

RADIO

ESTABLISHED, 1917

A 256

851K
DATA

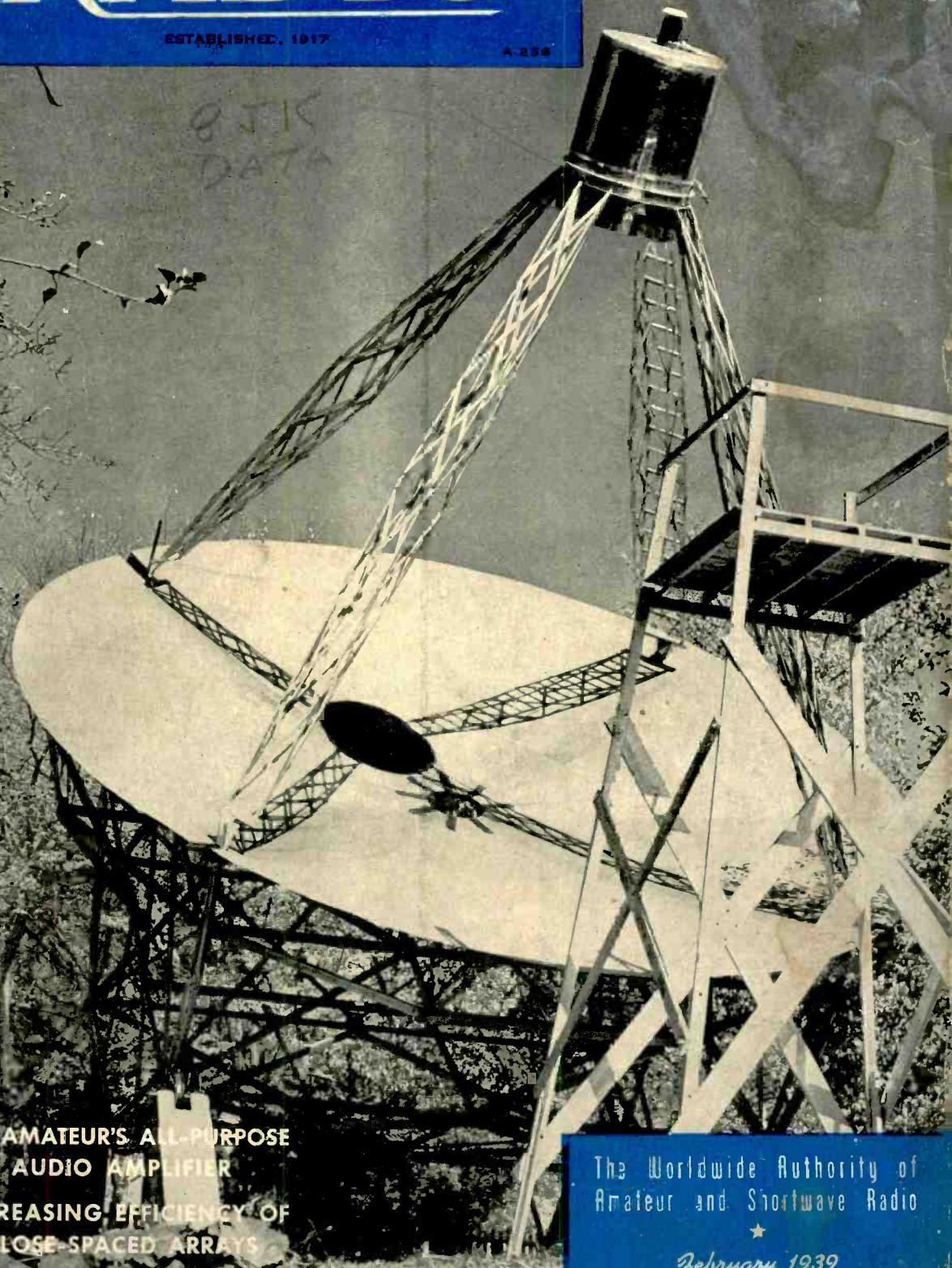

AN AMATEUR'S ALL-PURPOSE
AUDIO AMPLIFIER
INCREASING EFFICIENCY OF
CLOSE-SPACED ARRAYS

The Worldwide Authority of
Amateur and Shortwave Radio

★
February 1939

30¢ IN U.S.A. AND CANADA

1s. 6d. in United Kingdom

2s. in Australasia

USE

C.H.T. TRANSFORMERS

FOR . . .

- APPEARANCE
- PERFORMANCE
- ADAPTABILITY

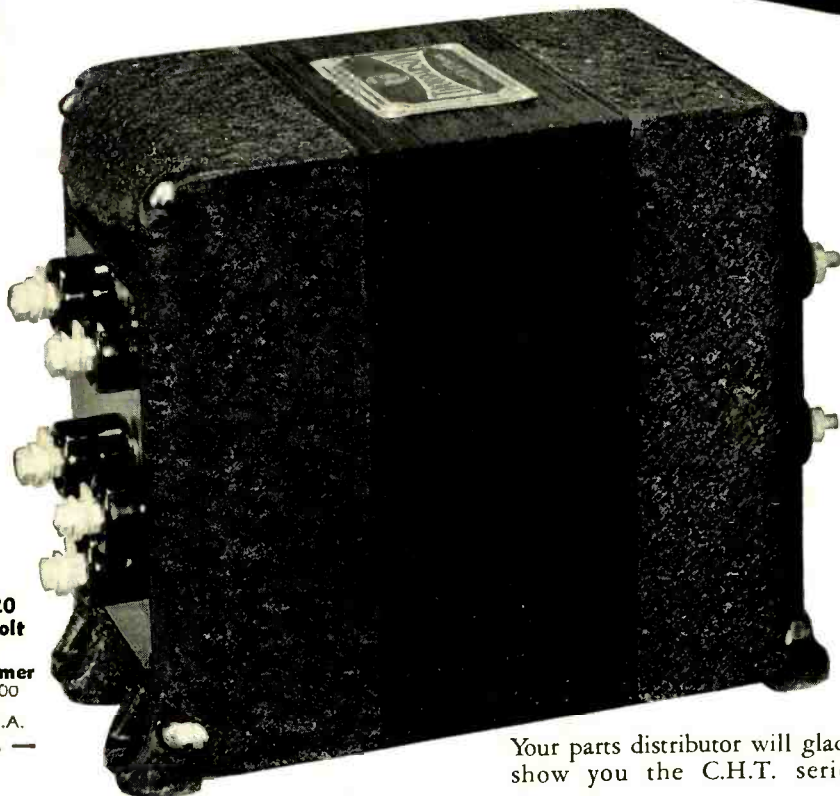

T-15P20
Multi-Volt
Plate
Transformer
2500-2000
Volts
at 650 M.A.
Wt. Lbs. —
140

Your parts distributor will gladly
show you the C.H.T. series.

THORDARSON ELECTRIC MFG. CO.

500 W. HURON ST., CHICAGO, ILL.

Demand "Power by Thordarson"

An Eimac Tube is an improvement for any transmitter.

POWER CONVERTERS

not power dissipators

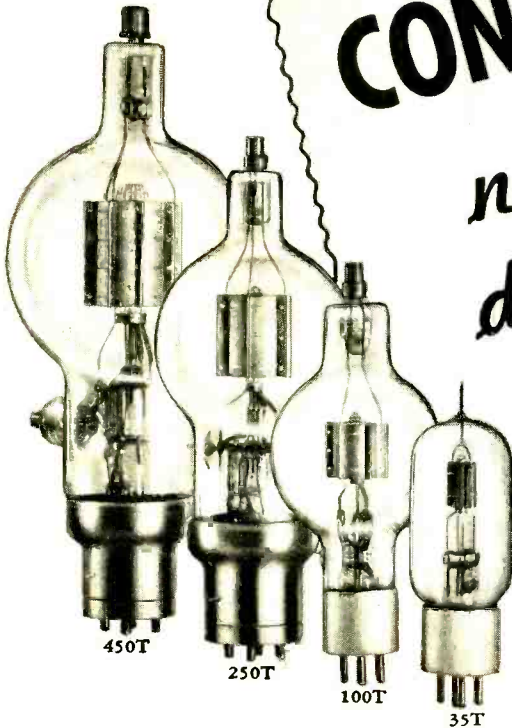

From the very beginning it has been the purpose of the makers of Eimac tubes to produce and make practical a vacuum tube having unlimited capabilities and extremely high efficiencies. Their ultimate goal (not yet achieved) being to get 5 KW output from a small tube like the 35T. How far they have succeeded is evidenced by the outstanding performance to be gained from Eimac tubes today.

Eimac is not "just another good tube." It represents a great step forward for the entire field of radio communications. Progressive radio engineers who refuse to cling to precedent . . . who wish to obtain outstanding results . . . to be ahead of the crowd . . . have found Eimac tubes to be a requisite. Even those who are satisfied with the old way of doing things find definite improvement when they change to Eimac. The point is: Eimac tubes are capable of far greater performance than the average equipment in use today is capable of producing.

With Eimac tubes, emission failure is almost a thing of the past. High voltages; high temperatures; gas will never affect an Eimac tube. That is why it is possible to get such extremely high power output from a comparatively small Eimac tube.

An example of Eimac's super performance is to be found in a group of new transmitters recently completed by the Thos. L. Siebenthaler Mfg. Co. to the design and specifications of TWA and Eastern Air Lines. In these transmitters, a pair of Eimac 450T tubes give an output of 4 KW while being operated well within their ratings. This kind of performance can easily be yours.

Eimac
TUBES

EITEL-McCULLOUGH, INC.
SAN BRUNO, CALIFORNIA

RADIO

7460 Beverly Boulevard, Los Angeles

Phone: York 7226 Teletype: LA 319 Cables: Radiopubs, Los Angeles

Branch Advertising Offices: NEW YORK, 101 W. 31 St., Phone: CHickering 4-7399
CHICAGO, 3606 N. Bernard St., Phone: JUNiper 5575

Production Office for "RADIO": EAST STROUDSBURG, PA., 45 Lackawanna Ave.
Phone: Stroudsburg 1734 Teletype: SDBG 74

Correspondence

Direct all manuscripts, subscription and book orders, payments, and general correspondence to the home office at Los Angeles. Regarding advertising, see notice at right. Unusable, unsolicited manuscripts will be destroyed unless accompanied by a stamped, addressed return envelope.

Notes

SUBSCRIPTION RATES: Two years, \$4.00, or \$2.50 yearly in U. S. A. (add 3% tax in California), Canada*, Newfoundland*, Cuba*, and Mexico*. To Pan-American countries and Spain, \$0.50* per year additional. Elsewhere† (except New Zealand), \$1.00* per year additional. New Zealand only: 13s.6d. yearly, local currency, from Te Aro Book Dept. Ltd., 64 Courtenay Place, Wellington. Special issues are included only with subscriptions of one-half year or longer. Refunds on cancelled subscriptions will be made at the difference between the rate paid and the rate earned.

THREE YEAR SUBSCRIPTIONS at the rate of \$5.00, net, in advance, are accepted from the U. S. A. and contiguous countries* only. Such subscriptions must be sent direct to our home office, not through agents.

SINGLE COPY PRICES: Prices are for regular issues; prices for special issues may vary but are usually those shown in parenthesis. At newsdealers, book stores, and radio parts dealers, 30c (50c) per copy in U. S. A. and Canada. By mail, postpaid, from home office, 30c (50c) in U. S. A., Canada*, Newfoundland*, Cuba*, and Mexico*; 35c* (55c)* in other Pan-American countries and Spain. Elsewhere†, 40c* (65c)*.

BACK ISSUES, when available, 5c extra net. Back issues will not be included in subscriptions.

***REMITTANCES** must be payable at par in continental U. S. A. except as follows: Canadian bank, postal, and express orders and postal notes accepted; add 10c exchange to Canadian bank checks. From elsewhere, remit by bank draft (preferred) or international money order.

†**BRITISH remittances:** for the convenience of British customers we quote sterling prices (and accept British postal orders and cheques payable at par in London) valid whenever £1 = \$4.70 or more. When exchange is lower, increase sterling amount proportionately or remit in dollars. Subscriptions: 1 year, 14s. 6d.; 2 years, £1 7s. Single copies: 1s. 3d. (special issues, 2s. 9d.; see above).

The Editors of "Radio"

EDITOR

W. W. Smith, W6BCX

ASSOCIATE EDITORS

Ray L. Dawley, W6DHG

Frank C. Jones, W6AJF

K. V. R. Lansingh, W6QX

E. H. Conklin, W9FM

CHICAGO

CONTRIBUTING EDITORS

Herbert Becker, W6QD

R. P. Turner, W1AY

EDITORIAL AND TECHNICAL ASSISTANTS

R. L. Norton, W6CEM

Faust R. Gonsett, W6YR

Jack Rothman, W6KFK

Kennard D. Moore, W6PDB

B. A. Ontiveros, W6FFF, Technical Draftsman

Business Staff

Los Angeles

K. V. R. Lansingh, Publisher

M. M. Lloyd, Managing Editor

A. McMullen, Editorial Secretary

John Snetsinger, Circulation and Advertising

Manager; E. M. Johnson, Assistant Advertising

New York

V. R. Lansingh, Eastern General Manager

Chicago

C. W. Nelson, Asst. Advertising Manager

East Stroudsburg

W. E. McNatt, Jr., Managing Editor

Advertising

Advertising inquiries may be directed to our nearest office. For fastest service, prepare advertising copy in duplicate; send original copy and cuts (fully mounted and mortised) to East Stroudsburg where "Radio" is printed; send duplicate copy, proofs of cuts, and space order to the advertising department at Los Angeles. No advertisement will run until the home office telegraphs its approval.

Miscellaneous Notices

IF YOU MOVE notify us in advance. We cannot replace copies sent to your old address. See "Changes of Address" notice elsewhere in this issue.

Radio is published ten times yearly (including enlarged special annual number) about the middle of the month preceding its date; August and September issues are omitted.

PUBLISHED BY RADIO, Ltd., Technical Publishers, 7460 Beverly Blvd., Los Angeles, California, U. S. A.

COPYRIGHT, 1939, by Radio, Ltd. All rights reserved. Reproduction without written permission is prohibited; permission is usually granted amateur radio papers on request.

TITLE REGISTERED at United States Patent Office.

PRINTED IN U. S. A. by Hughes Printing Company, East Stroudsburg, Pennsylvania.

RESPONSIBILITY will not be accepted for subscriptions placed with unauthorized agents. Prospective subscribers are urged to select carefully the credentials of anyone soliciting their business. Agents are never authorized to vary the rates quoted on this page.

BRANCH OFFICES transact a cash business with customers who call in person; mail orders and orders on open account should be sent only to Los Angeles.

Principal Foreign Agents

Europe: N. E. Read, 24, Church St., Oswestry, Shropshire, England. Australia: "The Bulletin", Box 2521BB, Sydney; McGills, 183 Elizabeth St., Melbourne; Swain & Co., Pitt St., Sydney. New Zealand: Te Aro Book Depot, Ltd., 64 Courtenay Place, Wellington. South America: F. Stark, Caixa 2786, Sao Paulo; "Revista Tecnografica", Peru 165, Buenos Aires; Editorial Pan America, Peru 677, Buenos Aires. South Africa: Trust African Radio Publications, 40 Trust Buildings, Fox Street, Johannesburg.

*The Worldwide Technical Authority of
Amateur, Shortwave, and Experimental Radio*

RADIO, February, 1939, no. 236. Published monthly except August and September by Radio, Ltd., 7460 Beverly Blvd., Los Angeles, Calif. Entered as second-class matter Feb. 6, 1936, at the postoffice at Los Angeles, Calif., under the Act of March 3, 1879. Additional entry at East Stroudsburg, Pa. Registered for transmission by post as a newspaper at the G.P.O., Wellington, New Zealand.



As the spirit moves, we present in this column from time to time a bit of gossip about RADIO, its affiliated publications, and those who produce and distribute them.

"—From the private life of RADIO."

It Works

A number of inquiries have been received wondering how RADIO's long-distance setup is working. Not badly, thank you; of course there are some headaches, but time and a large bottle of aspirin will eliminate most of these. And reports show that RADIO is reaching most of its readers more promptly than heretofore, although we'd be the last to deny that there's still room for improvement on that score.

For Advertisers

Advertisers and their agencies are respectfully requested to note that effective with the next issue the Production Office for RADIO and the RADIO *Handbook* has been moved to 45 Lackawanna Ave., East Stroudsburg, Penna., to which all advertising copy and cuts should be directed.

Staff Personal?

Once in a while the Publisher, who usually has the unwelcome job of "grinding out" this column, takes unfair advantage of his authority by sending it directly to the Production Office for publication, without the Editor's OK, a practice which outrages all the ethics of the better portion of the publishing industry. And we're wondering if our reader(s?) would like us to do it again to bring you a little personal dope on the Editor himself, dope which would never otherwise get by his well-wielded blue pencil. Drop a line to this column, won't you, if you would like the low down on our staff?

Location Wanted

The Publishers of RADIO are seeking new and larger quarters. If any of our readers happen to know of the availability of something approximately fulfilling the following requirements he will do us a great favor if he will advise us.

1. The location should preferably be within the delivery limits of the Los Angeles postoffice or, possibly, some contiguous town. Locations in or near Santa Barbara or San Diego *might* be considered if the location and buildings are unusually suitable. No other cities will be considered at present.

2. If in or near Los Angeles it should be within the limits of the Los Angeles telephone exchange or near enough so that a Los Angeles telephone would not be prohibitive in cost.

3. The location should be *off* a main street yet on land zoned for business; the lot should be at least 125 feet square, preferably somewhat larger. The neighborhood should be quiet and nice.

4. A reasonably good radio receiving location is desired; one likely to be excessively noisy electrically will not be considered.

5. The lot should have a suitable building of at least 12 rooms, most of which need not exceed 9' x 9' in size; we prefer to be the exclusive occupants of the building.

6. We will take a long-term lease with an option to buy, or we will consider an offer from an investor who wishes to buy land and build according to our specifications; estimated investment, \$15,000 to \$20,000.

Annual Issue

A few readers have wondered why we get out an annual double-size number. There are several reasons. For one, we like it—although we're not always so "hot" about the work of getting out twice as much material in the usual length of time. Then, perhaps, it helps partially to "make up" for the two summer issues which RADIO omits as most readers now know. And it's a little more suitable than an average issue in which to include certain semi-permanent reference items, such as tables and the annual index. And lastly, it seems to be liked by our readers; at least, more copies of that issue are sold than of any other throughout the year, despite its higher price.

Announcing the

RADIO

Technical Digest

as successor to

THE RADIO DIGEST

- All former subscribers to "Radio Digest" will receive "Radio Technical Digest" for the balance of their subscription terms.
- A concise, well-written review of all that's happening in radio (except broadcast and entertainment), this digest has proved to be an indispensable aid to the person who, while he wants to be up-to-the-minute, hasn't the time nor money to spend reading everything that's published. The outstanding articles of the month in both foreign and domestic publications are reprinted or condensed; others are reviewed in thumb nail sketches.
- The technical world at a glance!

RADIO TECHNICAL DIGEST

BIMONTHLY

Two years, \$2.50 Overseas, \$3.00

7460 BEVERLY BLVD.

LOS ANGELES, CALIF.

The publishers assume no responsibility for statements made herein by contributors and correspondents, nor does publication indicate approval thereof.

Table of Contents

Frontispiece: Seasoning 806's at the factory	8
--	---

ARTICLES

Characteristics of Antennas with Closely-Spaced Elements— <i>John D. Kraus, W8JK</i>	9
An AC-DC Beam Power Amplifier— <i>Rufus P. Turner, W1AY</i>	20
100-Watts Per Cubic Foot— <i>J. D. Ryder, W8DQZ</i>	23
Pulsing Amateur Transmitters for Ionosphere Sounding— <i>Albert W. Friend, W8DSJ-W8KIU</i>	28
Push-Button Transmitter Control— <i>A. G. Sheffield, VE4SS</i>	35
An Amplifier to End All Amplifiers— <i>Tom Patterson, W6DDS</i>	38
Remote Control Switching without Wire Lines— <i>Herbert J. Gleed, Jr., W9BHP</i>	42
Reviving 80 and 160 Meter DX— <i>E. H. Conklin</i>	45
A 250-Watt Transmitter— <i>Irwin K. Wolfe, W2KTC</i>	48
Taking Ten for a Ride— <i>F. R. Gonsett, W6VR</i>	54
Flasher-Type Modulation Indicator— <i>Orbra Harrell, W4BIN</i>	57

MISCELLANEOUS FEATURES

From the Private Life of RADIO	5	The Saga of the Old Timer <i>Kermit Trimble, W9MFT</i>	92
An Effective Rotary Antenna	19	The Market Place	96
Screen Voltage on 6L6's	41	Advertising Index	96
The Anti Jitterer—"Paddy," G2IS	88	Buyer's Guide	97, 98

DEPARTMENTS

DX	61	112 Mc	72
Yarn of the Month	67	New Books	73
Postscripts and Announcements	68	Scratchi	74
56 Mc	69	The Open Forum	74

**THE WORLDWIDE TECHNICAL AUTHORITY OF
AMATEUR, SHORTWAVE, AND EXPERIMENTAL RADIO**

That Final Touch...

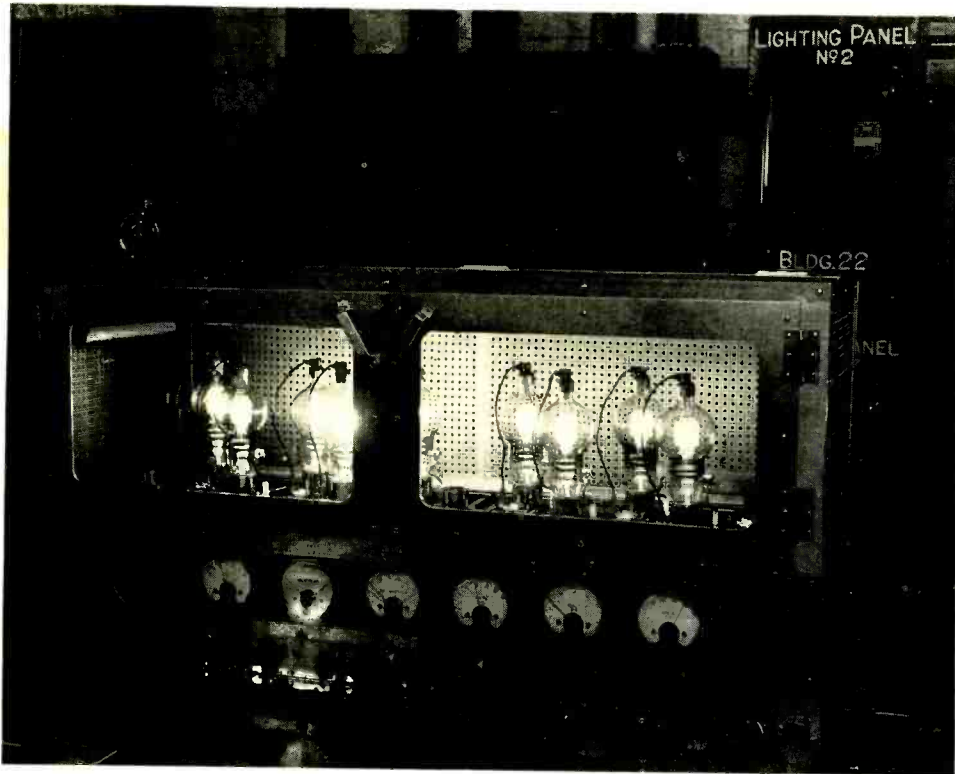

Seasoning a batch of 806's at the RCA factory to insure uniformity and permanence of characteristics.

Characteristics of Antennas With CLOSELY-SPACED ELEMENTS

Some pertinent facts pertaining to close-spaced antenna arrays are discussed such as effect of resistance losses on gain, effect of tilting the array, and best height above ground for various frequencies. The data apply particularly to the author's "Flat-Top Beam," but part of it also applies to other end-fire arrays having low radiation resistance, such as those of the close-spaced director-reflector type.

By JOHN D. KRAUS,* W8JK

For many years, spacings of one-quarter wavelength or more have been used between the parallel elements of directive antenna systems. It was first shown by G. H. Brown¹ that spacings of less than one-quarter wavelength were practical under many conditions. For convenience, we may speak of these arrays with less than quarter-wave spacing as antennas with "closely-spaced elements."

One of the chief benefits of close-spacing is that an array of excellent directional characteristics and substantial gain can be constructed in a relatively small space. This improvement is only obtained, however, at some sacrifice in the magnitude of the radiation resistance of the antenna. It is, in general, an inherent property of arrays with closely-spaced elements that the radiation resistance of the array elements is relatively low. This is not necessarily a serious disadvantage but is an item which merits consideration if an efficient radiating system is desired.

Antenna Efficiency

A transmitting antenna is an electrical device for handling radio frequency power. Its

main function is to radiate the power delivered to it into space. If all the power supplied the antenna is radiated, the efficiency is 100 per cent. In all practical cases, however, there are losses present and the radiating efficiency is less than 100 per cent.

Let us consider the case of a half-wave antenna. This antenna, when opened at the center or current loop point, presents a certain resistance, which is the total resistance of the antenna. This resistance is the sum of two parts, (1) the radiation resistance, R_r , and (2) the effective loss resistance, R_L . The fraction of the power delivered to the antenna which is "used up" in the radiation resistance is useful power and is radiated into space. Part of the power is dissipated in the loss resistance and occurs as heat in the antenna conductor, insulators supporting the antenna, or objects in the vicinity. From the standpoint of radiation, this power is wasted. Thus, the radiating efficiency of an antenna in per cent can be expressed as follows:

$$\text{Efficiency in per cent} = \frac{R_r}{R_r + R_L} \times 100.$$

It is apparent from this expression that if the radiation resistance is large compared to the loss resistance, the efficiency is high. This

* Arlington Blvd., Ann Arbor, Mich.

¹G. H. Brown, "Directional Antennas," *Proc. I. R. E.*, Jan., 1937.

is, in general, the condition with half-wave antennas well removed from the ground. In a typical case, the radiation resistance might be about 70 ohms and the loss resistance 2 ohms, giving an efficiency of about 97 per cent.

Suppose, however, that the radiation resistance of an antenna is only 2 ohms and that its loss resistance is also 2 ohms. The efficiency would then be 50%. To increase the efficiency, either the radiation resistance must be increased or the loss resistance decreased, or both.

The "Flat-Top Beam" Antenna

An example of arrays using closely-spaced elements is furnished by the "flat-top beam" antenna.² It is the primary purpose of this article to investigate the effect of loss resistance, and spacing, on the radiating efficiency of this type of antenna and also to find what effect height above ground and tilt have on its radiation characteristics. The distinguishing feature of a "flat-top beam" is that the currents in the closely-spaced elements are equal and out-of-phase. A number of other arrays using closely-spaced elements have similar current relations and hence some of the conclusions reached concerning loss resistance, height, and tilt for the flat-top beam also apply qualitatively to these other types. For example, an array consisting of a driven half-wave with a resonant parasitic director spaced one-tenth wavelength has current relations in the two elements which closely approach those of a flat-top beam.^{1*}

Loss Resistance and Spacing

The simplest kind of "flat-top beam" is the single-section type which has two parallel elements approximately one-half wavelength long. A spacing between the elements of one-eighth to one-quarter wavelength can be used. Figure 1 shows a single-section flat-top beam in both plan and end views. The antenna may be fed either at the center or from one end. The elements are spaced a distance, S , and are shown oriented horizontally at a height, H , above ground. The antenna may actually be operated with the elements either vertical or horizontal. In part of the following discussion the beam is considered to be in free

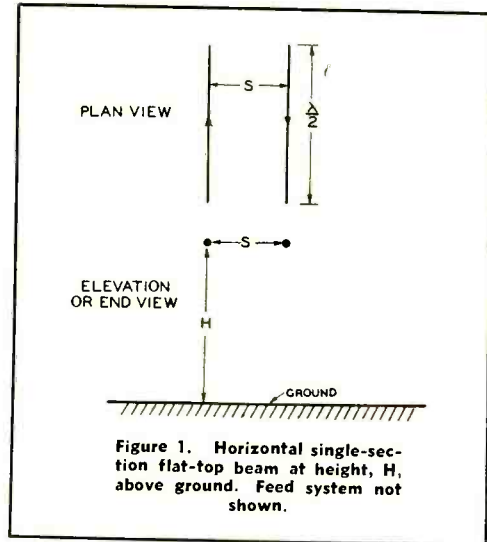

space, in which case the orientation makes no difference. The remainder of the discussion, including the treatment of the effect of height above ground and tilting, is confined, however, to the case of horizontal elements above ground. It is assumed that the half-wave elements are 180° in length and have the same current distribution.

The curves, R_1 , in figure 2 give the total resistance of either element of a single-section flat-top beam antenna. The two solid curves give the resistance when the beam is in free space and the dashed curves when it is horizontal and one-half wavelength above perfectly conducting ground. The lower curve of each pair is for the case of zero loss resistance (all radiation resistance) and the upper curves for a loss resistance of one ohm. At spacings of less than 0.05 wavelength the radiation resistance becomes very small and approaches the loss resistance in value.

As the spacing is increased the radiation resistance becomes greater. The curves, I_1 , in figure 2, show the variation of current in each element with spacing, assuming a constant power input of 100 watts to the beam. The upper curve gives the current if no losses are present and the lower curve when the loss resistance is 1 ohm. It is evident that the

² J. D. Kraus, "Small but Effective Flat-Top Beam," RADIO, March, 1937, and June, 1937; "Rotary Flat-Top Beam Antennas," RADIO, Dec., 1937; "Directional Antennas with Closely-Spaced Elements," QST, Jan., 1938; "Flat-Top Beam Antennas," *Television and Short-Wave World* (London), Feb., 1938; "New Design Data on the Flat-

Top Beam Antenna," RADIO, June, 1938; "Receiving with the Flat-Top Beam Antenna," *Radio and Television*, Nov., 1938; and R. R. Sprole and J. D. Kraus, "Optical End-Fire Directivity with the Flat-Top Beam," RADIO, Jan., 1938.

^{1*} *Loc. Cit.*, p. 106.

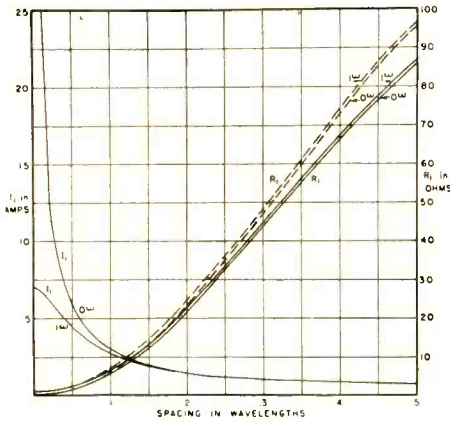

Figure 2. Resistance and current of each element of a single-section flat-top beam as a function of spacing.

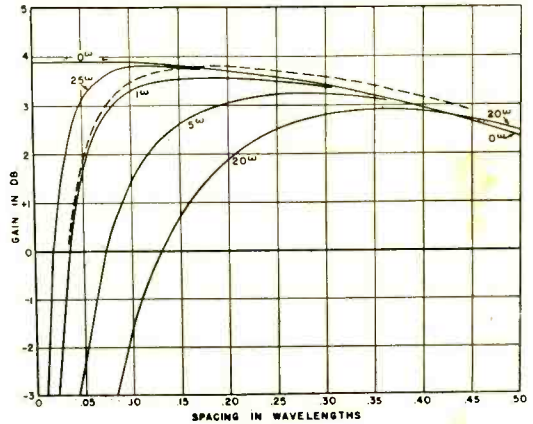

Figure 4. Gain of a single-section flat-top beam in free space as a function of spacing for various loss resistances.

current would reach extremely high values at very close spacings if the condition of zero loss could be realized.

According to figure 2, a single-section flat-top beam with one-eighth wavelength spacing has a resistance of about 9 ohms per element and a current of almost 2.5 amperes in each element for a power input of 100 watts to the beam. A single half-wave antenna with this input has a current of only about 1.2 amperes.

The effect of loss resistance on the radiating efficiency of a half-wave antenna in free space is shown in figure 3. One curve gives the loss in field strength in decibels and the other the power loss in watts for various loss resistances. A power input of 100 watts is assumed. It is evident from figure 3 that the loss resistance must be very large in order seriously to effect the radiating efficiency of a half-wave antenna. A loss resistance of 20 ohms causes

a decrease in field strength of only about 1 db. In practice, half-wave antennas operated a considerable distance above ground have relatively small loss resistances, probably only a few ohms at the most, so that the radiating efficiency is very high.

On the other hand, losses can have a much more important effect on the radiating efficiency of an antenna having a relatively small radiation resistance, such as an array with closely-spaced elements. The curves of figure 4 illustrate how the gain of a single-section flat-top beam varies with spacing for different values of loss resistance from zero to 20 ohms. The beam is considered to be in free space and the gain is referred to a single half-wave antenna also in free space. The gain is computed for a direction in the plane of the elements and perpendicular to them. It is a maximum in this direction.

It is apparent from figure 4 that if zero

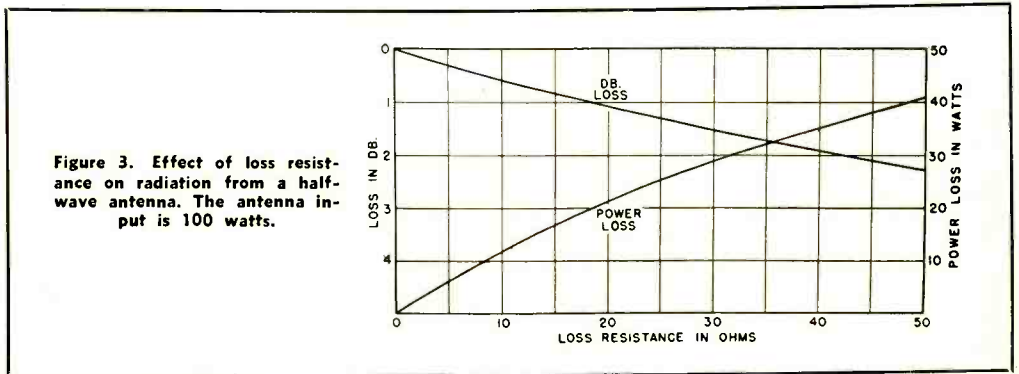

Figure 3. Effect of loss resistance on radiation from a half-wave antenna. The antenna input is 100 watts.

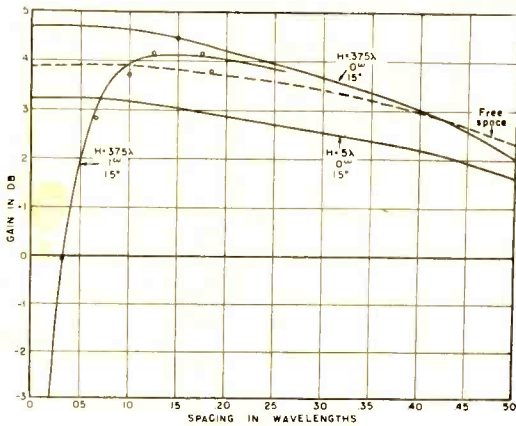

Figure 5. Effect of spacing on the gain of a horizontal single-section flat-top beam over a horizontal half-wave antenna when both are 0.375 (three-eighths) and 0.5 wavelength above ground.

losses are assumed, the beam maintains a gain of almost 4 db as the spacing is reduced to zero. This means that as long as the power output of the beam is constant, the gain is maintained even though the spacing becomes so small that the elements almost touch. In all practical cases, however, some loss resistance is present. With a loss resistance as small as 0.25 ohm per element, it is apparent that the gain falls sharply for spacings of less than 0.05 (one-twentieth) wavelength. In a typical installation the loss resistance per element may be of the order of 1 ohm. In this case it is evident from figure 4 that a spacing of about one-eighth wavelength is the minimum which can be used without some sacrifice in gain. The dashed curve in figure 4 shows the variation of gain with spacing when a loss resistance of 1 ohm per element in the beam and 5 ohms in the comparison half-wave antenna is assumed. For the solid curves the same amount of loss resistance is assumed for each beam element as for the reference half-wave antenna.

Although comparisons of antennas in free

space are of interest, it is also of practical significance to make the comparison at some definite height above ground. This has been done in figure 5. The uppermost curve shows the variation of gain with spacing of a horizontal single-section flat-top beam antenna at a height of 0.375 (three-eighths) wavelengths above ground and having zero loss over a horizontal half-wave antenna at the same height above ground. The curve which drops sharply at small spacings is for 1 ohm loss resistance per element. The dashed curve is one reproduced as a reference from figure 4, for the case of zero loss with the beam in free space. The lower curve shows the variation of gain with spacing when the beam and half-wave antennas are compared at a height of 0.5 wavelength above ground. The comparisons are made for a vertical radiation angle of 15° and perfectly conducting ground is assumed.

The small circles in figure 5 show the results of a gain-spacing test in which the field strength of a flat-top beam was measured for different spacings with a constant power input.

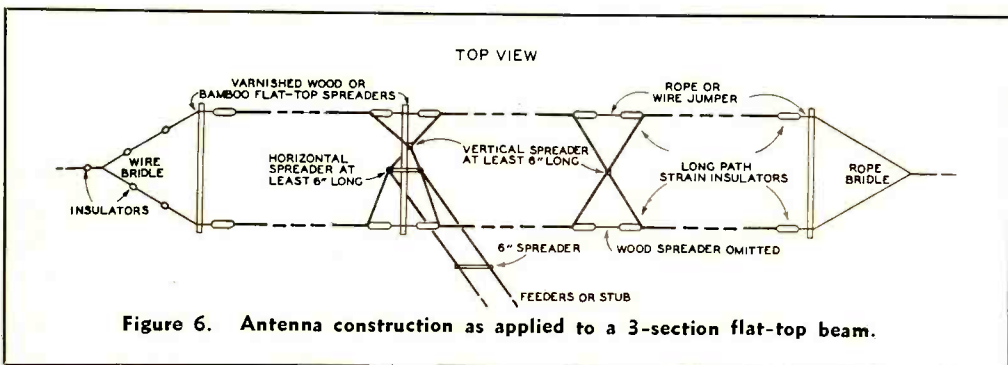
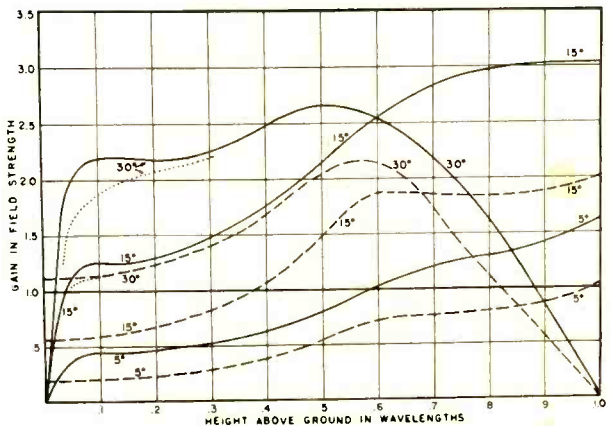

Figure 6. Antenna construction as applied to a 3-section flat-top beam.

Figure 7. Effect of height above ground on the gain of a horizontal single-section flat-top beam with one-eighth wave spacing (solid curves) and on the gain of a horizontal half-wave antenna (dashed curves) at vertical angles of 5°, 15°, and 30°. The gain is referred to a half wave in free space. Perfectly conducting ground is assumed.



Conclusions Concerning Spacing and Losses

The curves of figures 4 and 5 show that under practical conditions the gain of a flat-top beam falls off for both small and large spacings. The most useful range appears to be from about one-eighth to one-quarter wavelength. Larger spacings can be used at some sacrifice in gain if it is desired to increase the radiation resistance of the elements.

Some practical suggestions for reducing the effect of losses are as follows:

(1) Use sufficiently heavy wire for the flat-top elements and matching stub or feeder line. About no. 12 (B. & S. gauge) or larger is satisfactory. Solid, low resistance connections, especially at the shorting wire in the stub, are important.

(2) Use low-loss long-path insulators and the fewest number in parallel needed for good mechanical construction. Good quality glass or ceramic insulators 4 inches or more in length are satisfactory for the strain insulators. The insulators at the cross-overs should be at least 6 inches long.

(3) Keep the wires at cross-overs as far from the wooden spreaders as practical. This applies to the cross-overs in all types of flat-top beams except the single-section center-fed type, in which a voltage minimum is present at the center cross-over.

(4) The wooden or bamboo flat-top spreaders should be of the smallest cross-section consistent with strong construction. Coating these spreaders with lacquer or spar varnish is highly desirable.³ In the 4-section flat-top beam the wooden spreaders between the center and end sections may be dispensed with alto-

gether. This simplification was recommended by Charles Gault, W8ZO.

(5) Wire jumpers about a foot long can be used to advantage between the strain insulators and the end flat-top spreaders to remove the spreader farther from the high voltage field at the end of the antenna. See figure 6.

(6) Use as wide spacing as practical, up to about one-quarter wavelength. In a well constructed antenna a spacing of one-eighth wavelength may be equally as efficient. Wider spacing, however, is helpful in reducing detuning effects, as will be mentioned later.

(7) In the case of a single-section flat-top beam, the radiation resistance may be increased without increasing the spacing by lengthening the elements. The gain is practically unaffected by this change but the effect of any losses is reduced. For example, a 14-Mc. single-section center-fed flat-top might be made with elements 20 feet instead of 15 feet long each side of center.

Figure 6 shows the construction of a 3-section flat-top beam in which some of the means described above for reducing losses are illustrated. Rope or wire may be used for the bridle at each end of the flat top. If wire is employed, it should be broken up every 4 or 5 feet near the antenna with insulators.

Detuning

The discussion thus far has only been concerned with the efficiency of the antenna system. It is important also to consider the factors which affect the tuning of the array.

It is customary to adjust short-wave antennas to resonance. By so doing, the antenna can be made to appear as a resistive load to the transmitter or feed system. In the case of a flat-top beam this process is accomplished by locating the shorting wire in the matching

³ P. Gioga and R. L. Dawley, "The 3-Element Rotary," RADIO, Nov., 1938, pp. 15-16.

stub or by resonating the zepp feeders if the latter are used. In adjusting an antenna with a large radiation resistance the resonant point is generally quite broad. An array with a low radiation resistance, however, is more critical in its adjustment or tunes more sharply. It may be said that this array has a higher Q. Accordingly, any factors tending to produce detuning are more troublesome in an array with low radiation resistance.

Ordinarily, detuning is most noticeable during changes from dry to wet weather or *vice versa*. If the antenna is retuned to resonance the efficiency may be practically as good as before, but it is sometimes inconvenient to make these readjustments. Improvements made according to most of the seven recommendations of the preceding section with respect to losses also result in less tendency of the antenna to detune. Movement of the antenna elements, as in a high wind, also causes detuning. This can be reduced by means of greater mechanical rigidity.

Detuning effects in flat-top beam antennas are most noticeable with the single-section type having one-eighth wave spacing. The antenna may be improved in this respect by using wider spacing or longer elements, or both.

Other suggestions to reduce detuning effects are:

(1) The use of "non-wetting" feeder spreader and strain insulators. Such insulators, of glass or ceramic, are treated with wax which causes water to form in disconnected droplets on the surface rather than permitting it to make a continuous film of water over the insulator.

(2) The use of copper or aluminum tubing for the matching section or zepp feeders, and the use of as few feeder spreaders as is required to make the line rigid. In long stubs or zepp feeders considerable detuning may result from the change in effective diameter of the feeder wires when covered with a film of water. If large diameter wire or tubing is used the water film will cause a relatively

much smaller change in the size of the conductor. The change in capacitance of the line will thus be reduced and the detuning diminished. This statement applies particularly to the high voltage points in the feed line. It is of not as much importance, however, in the case of untuned or matched impedance transmission lines. The use of tubing in the stub would probably be of most value in the case of a single-section flat-top beam, especially if the stub is long. Shorter stubs or zepp feeders have less tendency to detune. From this point of view, a one-quarter wave stub is preferable to a stub three-quarters of a wavelength long. Stub or feeder spacing should be 6 inches, or a half-wave stub to one a wavelength long.

In addition to keeping the antenna in tune during changes of weather, it is often desirable to be able to operate the antenna over a rather wide range of frequencies without retuning the antenna. This range can be widened by increasing the radiation resistance of the antenna. In the case of a flat-top beam, this can be accomplished by using wider spacing. Spacings up to one-quarter wavelength can be employed with 1- and 2-section flat-tops, but it is not recommended to use over 0.15 wave spacing with 3- or 4-section types.

Some of the recommendations made in the above discussion concerning spacing, loss resistance, and detuning are only of minor importance. However, taken collectively these details may be helpful in improving the performance of a flat-top beam. Full information on the dimensions, construction, and adjustment of the different kinds of flat-top beams was given in RADIO for June, 1938, page 15. Design data are also given in the RADIO ANTENNA HANDBOOK, and the 5th edition (1939) of the RADIO HANDBOOK.

Height Above Ground

The height of an antenna above ground has an important effect on its performance. The solid curves of figure 7 show the variation of gain with height for a horizontal single-section flat-top beam. The spacing between the ele-

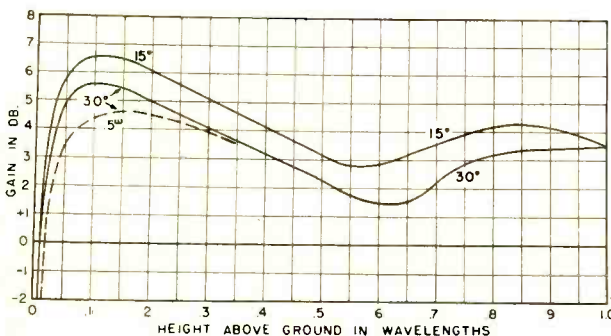
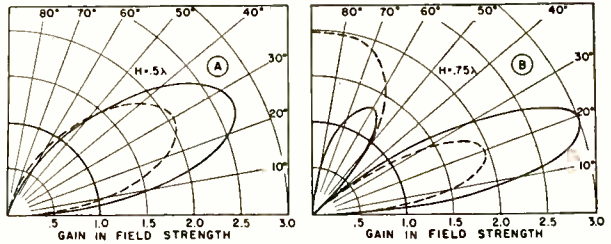

Figure 8. Effect of height on the gain of a horizontal single-section flat-top beam with one-eighth wave spacing over a horizontal half-wave antenna at the same height above ground for vertical angles of 15° and 30°.

Figure 9. Vertical plane radiation patterns of a horizontal single-section flat-top beam with one-eighth wave spacing (solid curves) and a horizontal half-wave antenna (dashed curves) when both are 0.5 wavelength (A) and 0.75 wavelength (B) above ground.



ments of the beam is one-eighth wavelength. The dashed curves show how the gain of a half-wave antenna varies with height. The gain in both cases is that broadside to the antenna and is referred to a half wave in free space with the same power input. Perfectly conducting ground is assumed. The gain is shown for vertical radiation angles of 5°, 15° and 30°. Zero loss resistance is assumed except for the dotted curves which show the effect of 0.5 ohm loss resistance on the 30° radiation.

At all except very small heights above ground, the flat-top beam shows an improvement over the half-wave antenna for all heights and vertical angles considered. It appears from figure 7 that for maximum radiation at vertical angles of 5° and 15°, it is desirable to use heights up to at least 1 wavelength for both the beam and half-wave antennas. For the 30° radiation the maximum occurs at a height of 0.5 to 0.6 wavelengths and a null is present at a height of 1 wavelength for both antennas. According to figure 7, the flat-top beam at a height of 1 wavelength has a gain in field strength at the 15° angle of more than 3 times over a half wave in free space or an improvement of 9.5 db. The half wave for this height and angle has twice the field, or is 6 db up, compared to a half wave in free space.

The extraordinary gains sometimes observed in comparing antennas may be explained by

figure 7. Let us compare, for example, a single-section flat-top beam at a height of 0.5 wavelength with a half-wave at a height of 0.95 wavelength. If the effective vertical radiation angle is 30°, the beam shows an improvement over the half wave of about 9 times in field strength or about 19 db, although the gain of the beam over the half wave is about 4 db when both are in free space.

Even when the beam and the half wave are compared at the same height above ground the gain may be considerably different from that in free space. This is indicated by the curves of figure 8 which give the gain of a single-section flat top over a half wave when both are at the same height above ground for vertical angles of 15° and 30°. The curve for 5° is very similar to the one shown for 15°. The dashed curve illustrates the effect of 0.5 ohm loss resistance on the gain of the beam for the 30° radiation.

It appears from figure 8 that the beam shows most improvement at heights of somewhat less than 0.2 wavelength. At a height of about 0.6 wavelength the beam shows relatively less improvement. This does *not* mean that the best height for the beam is less than 0.2 wavelength, but only that when compared with a half wave at the *same* height, the improvement is largest at this height. Actually the field strength from the beam may be much greater when it is 0.6 wavelength above

Figure 10. Variation of gain with vertical angle for a horizontal single-section flat-top beam with one-eighth wave spacing over a horizontal half-wave antenna when both are at heights of 0.5 and 0.75 wavelength.

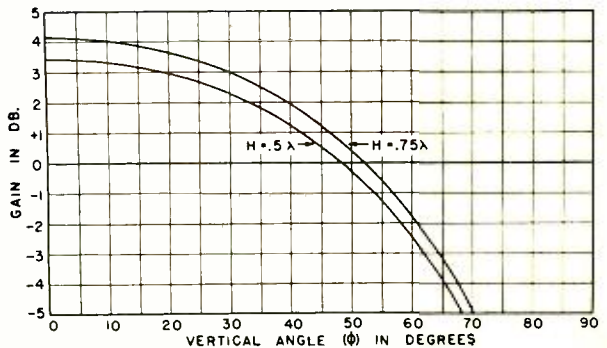

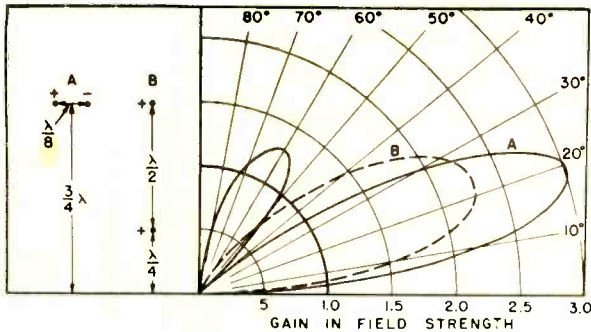

Figure 11 Vertical plane radiation patterns of a horizontal single-section flat-top beam (A) and an array of two stacked horizontal in-phase half-wave elements (B).

ground than when it is 0.2 wavelength, although it shows less improvement over a half wave in addition to the greater height.

In addition to showing the gain as a function of height as in figure 7, the gain may be given as a function of vertical angle. This is done in figure 9, in which the vertical radiation pattern of a single-section flat-top beam is compared with a single half wave when both are at a height of 0.5 wavelength, as shown at A, and 0.75 wavelength, as shown at B. The pattern of the flat top is indicated by the solid lines and the pattern for the half wave by the dashed lines. It is evident in both cases that the flat-top beam gives a marked increase in the radiation at low angles. This fact is also well illustrated by figure 10.

Conclusions Concerning Height

There is no one "best height" for all conditions. If we assume that vertical angles of about 30° are effective for communication under 1000 miles on 14 Mc. and that angles of 15° to 20° (sometimes less) are useful for longer distances, a height of 0.5 to 0.6 wavelength would appear to be favorable for all-around operation on 14 Mc. for both the beam and the half-wave antenna. If one desires to favor the lower angles suitable for long-distance communication, heights of 0.75 to 1 wavelength can be used. If we assume that on 28 Mc. angles of about 10° are most effective, heights of over 1 wavelength (actually between 1 and 2 wavelengths) are most suitable. An antenna at a height of 0.6 wavelength on 14 Mc. can thus be used to excellent advantage on 28 Mc. since on this band its height will be 1.2 wavelengths. Since on 7 Mc. the effective angle may be around 30°, heights of much more than 0.5 wavelength would not seem to be advisable for this band. These statements apply to both the beam and half-wave antenna but only when used horizontally. In any case, it is not desirable to use the flat-top beam at heights of much less than twice the flat-top spacing.

Closely-Spaced vs. Stacked Elements

Stacked horizontal half-wave elements are sometimes used to increase the gain of an antenna system.⁴ The elements are usually stacked 0.5 wavelength apart and operated in phase. A comparison has been made in figure 11 of the vertical patterns from a single-section flat-top beam having two elements spaced one-eighth wavelength and an array of two stacked elements spaced one-half wavelength. The arrangement of the arrays is shown in end view in the insert in figure 11. The flat-top beam is at a height of 0.75 wavelength, as shown at A, and the upper element of the stacked array is also at this height with the lower element 0.25 wavelength above ground, as shown at B. The gain is referred to a half wave in free space.

The curves of figure 11, solid for the flat top and dashed for the stacked array, show that the flat-top beam puts out considerably more signal at low angles. At a vertical angle of 10° the gain of the flat top over the stacked array is more than 3.5 db. Even if the flat top is lowered to a height of 0.5 wavelength it shows some improvement over the stacked array of figure 11-B at all vertical angles. This may be seen by comparing curve B of figure 11 with the solid curve of figure 9-A. One reason for the improvement of the flat-top beam over the stacked array is that the flat top has a slightly sharper horizontal pattern than a single horizontal half-wave antenna, while the horizontal pattern of the stacked array is substantially the same as that of a single half wave.

Tilt

An antenna with closely-spaced elements can be very easily tilted. The tilt referred to consists of a lowering or raising of one element of the array with respect to the other,

⁴ E. H. Conklin, "Antenna Gain without Horizontal Directivity," RADIO, May, 1937.

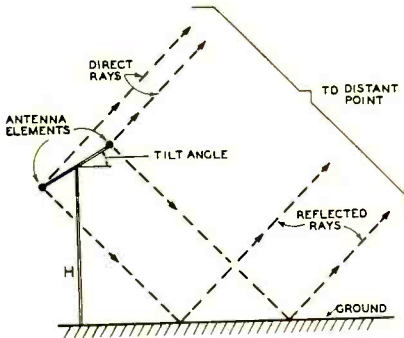

Figure 12. Tilted array with closely-spaced elements.

while keeping both elements horizontal. Figure 12 shows the end view of a tilted array with closely-spaced elements. The average height of the elements above ground is H . It is interesting to compute what change in the radiation pattern results from such tilting.

Figure 13 gives the vertical pattern perpendicular to the elements of a single-section flat-top beam with one-eighth wave spacing when horizontal (tilt = 0°) and when tilted 30° and 45° , as shown by the solid, dashed, and dotted curves, respectively. The average height of the beam is 0.5 wavelength above ground. Figure 14 shows the results of tilting when the beam is 0.75 wavelength above ground. Perfectly conducting ground is as-

sumed, and the gain is referred to a half wave in free space.

In all cases it is apparent that the tilting causes a decrease in radiation at low vertical angles and an increase at high angles. Furthermore, the effect on the pattern is the same whether the antenna is tilted up or down. This is indicated by the inserts in figures 13 and 14 which show the left-hand element lowered and the right one raised when the antenna is tilted. The vertical pattern in both directions broadside to the antenna is, however, the same. This results from the fact that the field strength at a distant point is the resultant of both the direct radiation from the antenna and that reflected from the ground, as indicated in figure 12. This is for perfectly conducting ground. Over actual ground, the pattern of a tilted flat-top beam may not be symmetrical as shown in figures 13 and 14 but will have a greater increase at high angles to the side of the antenna which is tilted up. However, low angle radiation would be reduced in both directions broadside the same as over perfectly conducting ground. An increase of radiation at low angles can only be accomplished by raising the antenna higher above ground.

As mentioned earlier, an array with a resonant half-wave director spaced one-tenth wavelength from a driven antenna has current relations very similar to those in a flat-top beam. Thus, tilting such an array would give the same kind of results: that is, a decrease of radiation at low angles and an increase at high.

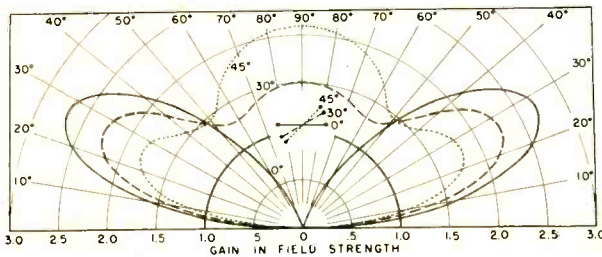
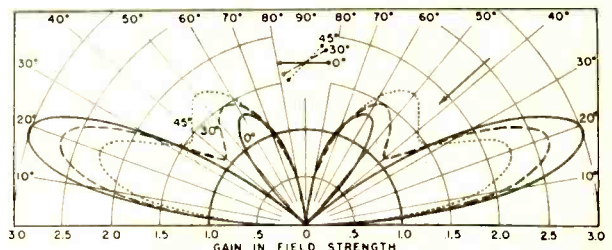

Figure 13. Effect of tilt on the vertical plane radiation pattern of a single-section flat-top beam with one-eighth wave spacing. The average height of the beam elements is 0.5 wavelength above ground.

Figure 14. Effect of tilt when the flat-top beam is 0.75 wavelength above ground.



FOR 14.0 TO 14.4 MC.

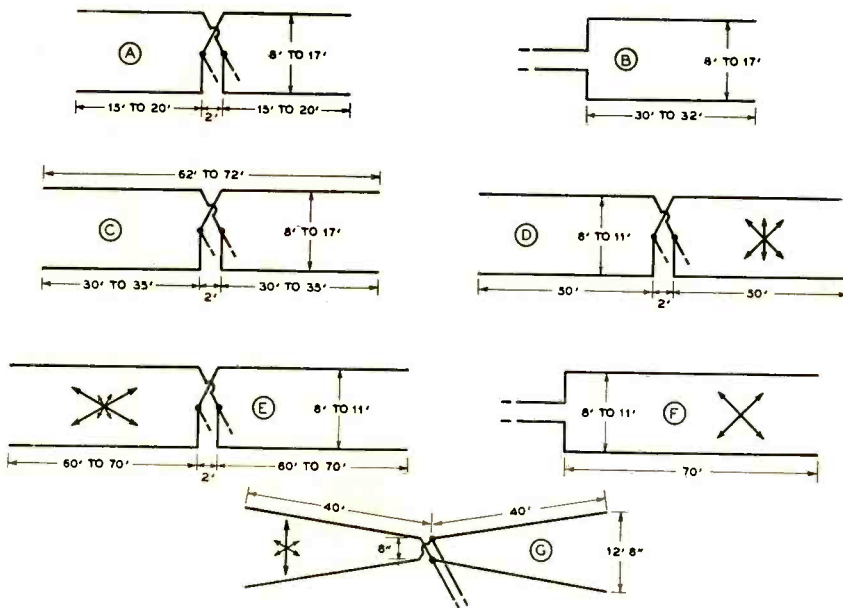

Figure 15. Types of extended flat-top beam antennas. Dimensions are for the 14-Mc. band. For 28 Mc. divide by two.

At some intermediate angles the radiation does not change much when the antenna is tilted. For example, in figure 13, the radiation at a 50° angle is almost unchanged for the different tilt angles considered. Therefore, depending on the effective vertical angle of the transmitted or received signal, the tilting may produce an increase, a decrease, or no change in the signal strength.

When the antenna is 0.75 wavelength above ground there is a null in the vertical pattern at about 42° . This is indicated by the arrow in figure 14. By tilting the beam the radiation at this angle is greatly increased. In other words, the tilting "fills in" the null. Thus, in cases where a flat-top beam or close-spaced array is used at heights of 0.75 to 1.0 wavelength or more, the signal may be improved on short skip contacts when high vertical angles are effective by tilting the antenna. On long distance contacts, however, the best position for the array would probably be horizontal.

In some locations the ground may slope in a direction broadside to the antenna. A horizontal close-spaced array above such sloping ground is equivalent to a tilted array above level ground. Therefore, it is apparent that

for maximum low angle radiation, the close-spaced array should be parallel to the ground rather than horizontal.

In computing the curves for certain figures in this article, the assumption of a perfectly conducting ground was made. It has been pointed out⁵ that for comparing *horizontal* antennas more than one-quarter wavelength above ground, this assumption yields very nearly the same results as would be obtained by making the comparison over most types of actual ground. It is true that the vertical plane radiation pattern may be somewhat different over actual and perfectly conducting ground, especially at the higher vertical angles, but the shape of the pattern will be qualitatively the same. Taking the gain of one antenna over another as done in figures 8 and 10, however, gives almost the same results for both perfectly conducting ground and most types of actual ground.

⁵ Friis, Feldman, and Sharpless, "Determination of Direction of Arrival of Short Radio Waves," *Proc. I.R.E.*, Jan., 1934, p. 53; see also E. H. Conklin, "The Effect of Average Ground on Antenna Radiation," *RADIO*, March, 1938; and Bruce, Beck, and Lowry, "Horizontal Rhombic Antennas," *Proc. I.R.E.*, Jan., 1935, p. 27.

Extended Flat-Top Beam Antennas

A single-section center-fed flat-top beam is shown in figure 15-A. There is considerable flexibility in the dimensions given, which are suitable for the 14-Mc. band. The length of the elements may be 15 to 20 feet and the spacing 8 to 17 feet. As was mentioned earlier, lengthening the elements from 15 to 20 feet increases the radiation resistance of the antenna but has very little effect on the gain.* This change also results in a shorter stub. The use of the largest dimensions given provides a high radiation resistance.

If the single-section flat-top beam is to be used only on its fundamental frequency, or 14 Mc., the elements may be extended even more. In fact, they can be made anywhere from 15 to about 30 feet long with only a small effect on the horizontal radiation pattern. With 30-foot elements the antenna is actually a 2-section 14-Mc. flat-top beam. This means that any lengths between the 1- and 2-section types can be employed. If, however, the antenna is to be used on its second harmonic, i.e. 28 Mc., the elements should not be more than about 17 feet if the same type of bidirectional horizontal pattern is desired on both 14 and 28 Mc. The longer elements introduce lobes of radiation at angles other than broadside on the harmonic frequency. In some cases this may be desirable. Thus, a 2-section 14-Mc. flat top gives a 4-lobed pattern when used on 28 Mc. The maximum of these lobes lies from 40° to 50° from the flat-top wires.

A single-section end-fed flat-top beam is shown in figure 15-B. The length may be 30 to 32 feet and the spacing 8 to 17 feet.

The other arrays shown in figure 15 are also extended types but the effect of the extension is not the same as for the single-section type. The type at C is a 2-section center-fed type, the lengths of each section being 30 to 35 feet. The spacing may be 8 to 17 feet. The longer elements (35 feet) produce a slight increase in broadside gain, about one-half decibel, but little change in radiation resistance. The increased gain is obtained through a narrowing of the horizontal radiation pattern. Extending the elements to more than 35 feet would give slightly more broadside gain but would introduce lobes of radiation at angles other than broadside. If space permits greater length, and more broadside gain is desired, a 3- or 4-section flat-top beam can be used.

* G. H. Brown, "A Critical Study of the Characteristics of Broadcast Antennas as Affected by Antenna Current Distribution," *Proc. I.R.E.*, Jan., 1936.

The type at D is a 2-section flat top with sections each side of center which are approximately three-quarters of a wavelength long. This type has been used by L. C. Verhyden, W9TIZ, and gives a radiation pattern roughly as shown by the arrow diagram. There are six lobes of radiation in the horizontal plane, four large ones making an angle of 40° to 50° with the elements and two smaller lobes broadside.

The array in figure 15-E is a center-fed 2-section type with about one wavelength each side of center. The pattern has four main lobes of radiation approximately as indicated. The type at F is end fed with a single section which is about one wavelength long. The arrays shown in figure 15-D, E and F may have spacings of 8 to 11 feet. Although these types are not as suitable for general coverage in one or two directions as the standard flat-top beams of 2 to 4 sections, they may be convenient in some locations.

The antenna in figure 15-G is a tapered 2-section 14-Mc. flat-top beam with elements extended to 40 feet. The sections taper from 12.5 feet at the ends to 6 inches at the center. The longer elements give a narrower broadside beam and should provide somewhat more gain. Due to the extended elements, however, minor lobes of radiation are introduced at angles other than broadside. The closer spacing at the middle of the antenna is intended to suppress partially the radiation from the central portion and reduce the size of the minor lobes. Although this array appeared promising, an antenna of the dimensions of figure 15-G was found by field strength measurements to show almost no improvement in broadside radiation over a conventional 2-section flat-top beam having constant 8-foot 8-inch spacing and 30-foot elements. The conventional type has the added advantage of a broader horizontal pattern with no minor lobes.

AN EFFECTIVE ROTARY ANTENNA

An interesting and effective rotary antenna structure is that of a Los Angeles ham who is an aircraft engineer.

We'll let the designer, W6NKF, tell in his own words how the array came into being: "After listening to a number of good signals on the ten-meter band, I was impressed with

[Continued on Page 90]

A N A . C . - D . C .

Beam Power Amplifier

Here is an easily duplicated 8-watt amplifier or modulator that works equally well on a.c. or d.c. No special switching is required when changing from one type of current to the other. The gain is sufficient to accommodate a crystal or velocity microphone for far-off talking.

By RUFUS P. TURNER,*

W1AY

The 25L6 beam power tube has made it possible to obtain a goodly number of audio watts in straight 110-volt operation, without benefit of filament and plate power transformers. At the same time this remarkable tube has offered numerous obvious advantages not afforded by its predecessors, the 43, 48 and 25A6. Hams stranded in d.c. districts should welcome the 25L6 to their hearts.

The beam power amplifier described in this article employs four 25L6 tubes in push-pull parallel in the output stage to give an output of approximately eight watts. The four 25-volt heaters of these tubes are wired in series and connected across the 110-volt line through a 6.3-volt pilot lamp. Two 25Z5 rectifiers are used in the "transformerless" power supply, and the 25-volt heaters of these tubes are wired in series with the 6.3-volt heaters of the four other tubes in the amplifier (a single 6J7 and three 6C5's) and connected across the 110-volt line through a 116-ohm 25-watt fire-proof wirewound resistor. In every other respect the amplifier resembles any conventional speech amplifier with the same number of resistance-coupled and transformer-coupled stages.

The writer's a.c.-d.c. speech amplifier had to toe a big mark. The first requirement was that it handle a ribbon velocity microphone (with an output level of minus sixty-eight db) so well that the operator might talk from a "safe" distance. Close talking into a velocity mike imparts an obnoxious boominess to the speech quality.

Equally uniform performance on both

alternating and direct current was desired, since the writer desired to use the amplifier *in 1010* after moving to an a.c. neighborhood. This high degree of versatility was obtained after an additional decoupling filter (shown in the circuit diagram) was added and the heater wiring rearranged to remove the only vestige of a.c. hum.

The power output had to be sufficient to "spank" modulators employing any of the newer medium output tubes, or to modulate directly a low-powered 110-volt d.c. or a.c.-d.c. transmitter.

Construction

In order to minimize hum pickup, the amplifier and power supply sections are built upon separate chassis, 17" x 6½" x 2" and 11" x 7" x 2" respectively. The chassis were formed in a sheet metal shop from 0.054" steel and spot-welded. Considerable difficulty was experienced with hum in the first model, which was mounted completely upon one chassis. On d.c., the same model gave a large amount of d.c. line noise.

The two units are connected electrically by means of an eight-conductor cable, each end of which terminates in an octal base plug. Octal sockets are mounted on the back of each chassis to receive these plugs.

The tubes in the low-level stages are mounted in a straight line along the rear of the amplifier chassis (see figure 1). The low-level transformers are to the front. The four 25L6 output tubes are arranged in a square between the push-pull low-level stage and the output transformer.

* Contributing Editor, RADIO.

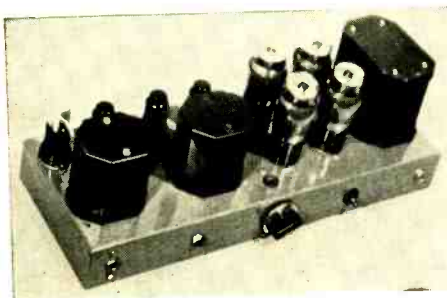

Figure 1.

The amplifier is laid out on a standard metal chassis as illustrated above.

Along the front edge of the amplifier chassis, from left to right, may be seen the shielded microphone jack, pilot light, gain control dial, line switch, and output jack. The rubber grommet on top of the chassis, directly above the gain control dial, insulates a hole through which leads from a db meter are passed for connection to the output winding of the 25L6 transformer.

The microphone jack is enclosed in a small tight-fitting shield can, together with the radio-frequency choke and 6J7 grid leak. The 6J7 grid lead is shielded throughout its length, the lower end of the shield being bonded securely at the point where it enters the jack shield. A tight gripping shield cap is placed on top of the 6J7 tube. This input stage is particularly susceptible to r.f. pickup and extensive shielding is necessary. Some successful builders prefer to enclose the entire input stage with all its associated resistors and condensers and the gain control for the succeeding stage in a tight shield box.

Leads to the gain control potentiometer pass through shield braid grounded at several points along its length. If the metallic back of the potentiometer "floats," this should also be grounded.

All parts are mounted so as to afford the shortest possible leads. One terminal of both microphone and output jacks is grounded. By-pass condensers are mounted sturdily between instrument terminals or from a terminal to a chassis-ground lug, with the shortest possible pig-tail length. All resistors are supported by insulated lugs.

In the top view of the power supply chassis (see figure 2) are mounted the 225-ma. filter choke for the 25L6 power supply, the two 25Z5 rectifier tubes and the four 16- μ fd. 200-volt electrolytic condensers. Beneath the chassis are the 30-henry midget a.c.-d.c. receiver type choke used in the filter for the

low-level stages, the two line fuses, and the 0.1- μ fd. line by-pass condenser.

The toggle switch on the front of the amplifier chassis is a line switch, permitting control of the power supply from the operating position, which may be some distance away, depending upon the length of the cable. The two switch leads extend through the 8-conductor cable to the power supply. The pilot light burns only when the amplifier is running.

Wiring and Electrical Description

The circuit diagram is shown in figure 3. It will be noted that adequate decoupling filters are provided. One-hundred-ohm $\frac{1}{2}$ -watt parasitic suppressing resistors are connected between control grid terminals in the push-pull parallel stage, as indicated. The heaters of the low-level tubes are wired in the order shown in the schematic, one 6J7 heater terminal being grounded as close to the socket as possible. The pilot light is shunted by a 63-ohm resistor fastened directly to its socket. This resistor may be made from resistance wire salvaged from an old rheostat and wound on a strip of fiber. A fairly heavy size of wire is recommended, since thin wire will heat considerably in this resistor.

If hum or instability is encountered in the 6J7 stage, it may become necessary to try several different chassis points for grounding the grid leak, cathode resistor and condenser, and screen by-pass condenser. It may also be necessary to experiment to some extent with new 6J7 tubes to find one that is both non-microphonic and free from hum.

The plate circuit of the second 6C5 stage is parallel-fed. Keeping the direct current out of the transformer primary was purely a matter of precaution. One fellow who duplicated the amplifier used series feed and experienced no

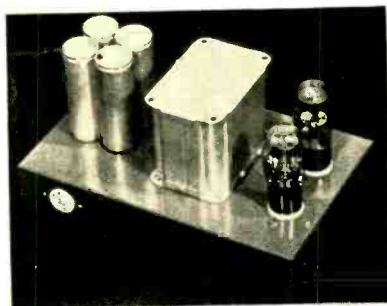

Figure 2.

The power supply is made external to minimize hum. Two 25Z5's in parallel are used to provide sufficient current handling capacity.

RADIO

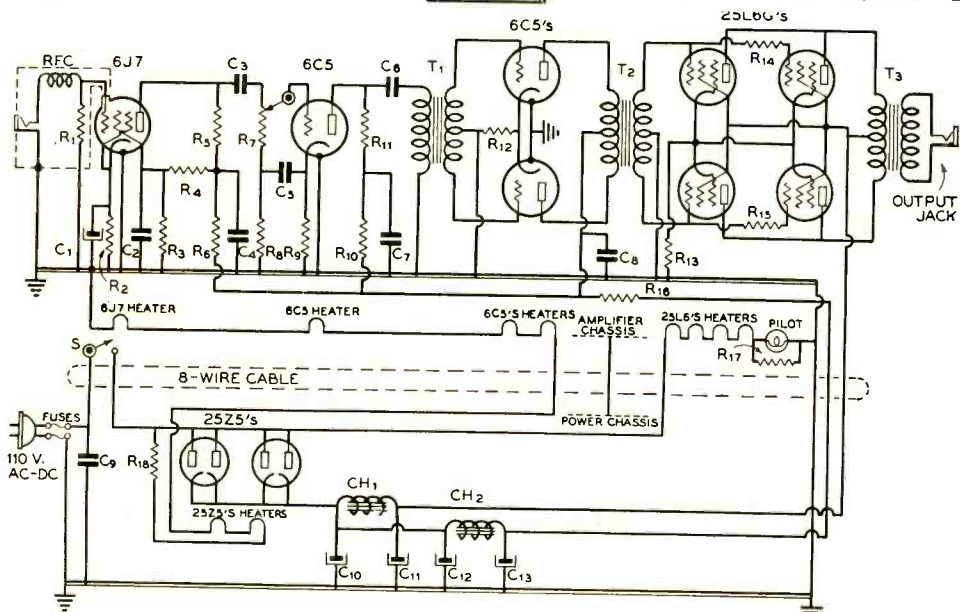

Figure 3.—General wiring diagram of the amplifier and power supply.

C ₁ —10- μ fd. 25-volt electrolytic	μ fd. 250-volt electrolytic	R ₁₀ —10,000 ohms, 1/2 watt	p.-grids, 1:2 ratio
C ₂ —2- μ fd. 200-volt paper	R ₁ —5 megohms, 1/2 watt	R ₁₁ —50,000 ohms, 1/2 watt	T ₂ —Push-pull-plates-to-push-pull-grids, class-A
C ₃ —0.1- μ fd. 200-volt tubular	R ₂ —3500 ohms, 1/2 watt	R ₁₂ —500 ohms, 1/2 watt	T ₃ —Variable-match 10-watt output transformer
C ₄ —2- μ fd. 200-volt paper	R ₃ —50,000 ohms, 1/2 watt	R ₁₃ —40 ohms, 10 watts	CH ₁ —20 henry, 225 ma.
C ₅ —0.5- μ fd. 200-volt tubular	R ₄ , R ₅ —250,000 ohms, 1/2 watt	R ₁₄ , R ₁₅ —100 ohms, 1/2 watt	CH ₂ —30 henry, 75 ma.
C ₆ —0.1- μ fd. 200-volt tubular	R ₆ —50,000 ohms, 1/2 watt	R ₁₆ —2500 ohms, 1 watt	RFC—2.5-mh. r.f. choke
C ₇ , C ₈ —4- μ fd. 200-volt tubular	R ₇ —500,000-ohm potentiometer	R ₁₇ —63 ohms, (see text)	S—S.p.s.t. toggle switch
C ₉ —0.1- μ fd. 400-volt tubular	R ₈ —100,000 ohms, 1/2 watt	R ₁₈ —116 ohms, 25 watts	Fuses—5-amp. glass cartridge type
C ₁₀ , C ₁₁ , C ₁₂ , C ₁₃ —16-	R ₉ —3500 ohms, 1/2 watt	T ₁ —Single-plate-to-p.	

particular difficulty. In his case, the transformer did not seem to be saturated and the quality sounded identical.

The two 25Z5 rectifier tubes have their plates connected in parallel and cathodes in parallel to supply plenty of plate and screen current to the amplifier. The parallel arrangement proved more desirable than a bridge circuit first tested. Two separate filters are employed, one handling the 25L6 stage alone, the other supplying the low-level stages. Each filter is brute force, with a pair of 16- μ fd. 200-volt electrolytic condensers. The small choke for the low-level stages is a standard replacement item for a.c.-d.c. midget receivers.

The two fuses, each a 5-ampere miniature glass plug type, have saved many a house fuse when probing around the amplifier's inwards with a screwdriver. The 0.1- μ fd. line

by-pass condenser might be dispensed with in some locations, but it is best to install it in the first place.

The output transformer is of the "universal" type designed to accommodate a wide variety of tubes in single-ended, push-pull or push-pull parallel circuits and to provide output impedances of 500, 200, 16, 8, 5, 3 and 1.5 ohms. The selected output taps are connected directly to the output jack. The writer makes use of the 500-ohm connection, with a 500-ohm line-to-grid input transformer in the modulator.

All leads must be kept as short as possible. The heaters are wired with heavy, semi-rigid hookup wire kept close to the chassis. Carelessness in wiring this heater circuit can result in considerable grief occasioned by hum.

[Continued on Page 82]

100-WATTS

Per Cubic Foot

Figure 1. Front view of the transmitter as described in the article. The blank center panel is to be for the modulator and power supply when the rig is rebuilt for high-level modulated phone. At present the power supplies are on the bottom panel and the r.f. section is built upon the top one.

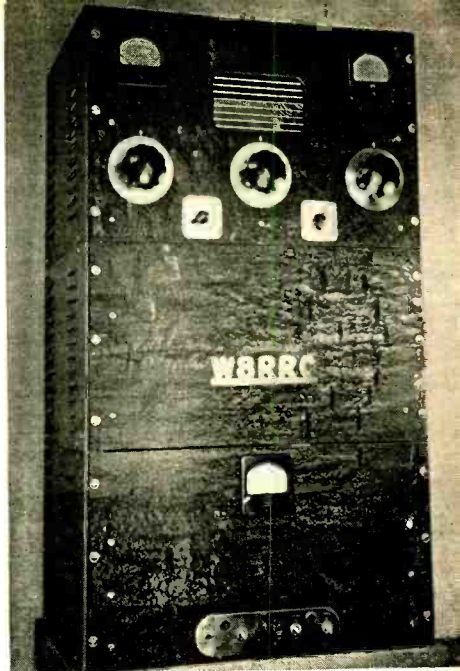

By J. D. RYDER,* W8DQZ

Why should a 500-watt phone-c.w. transmitter cover both sides of a six-foot rack and then extend over into the parlor? Why should the r.f. section be spread over two or three chassis bases and have four or more stages of frequency doublers, triplers or maybe even quintuplers, all with dials and parasitics? Why bias power supplies when all you need are some negative volts and the other power supplies have plenty of those? Well, why?

The writer, having acquired some definite opinions on the above subjects over a period of years of operating and being perfectly willing to pass them along as free advice to all comers, finally had an opportunity to do something about it in building a new transmitter from the ground up.

After thorough search no really good reasons could be found for any of the above practices so we decided that this time the program was really going to be different. There are only three general functions to be performed in a transmitter: (1) d.c. power supply, (2) r.f. generation and, (3) modulation. What is more logical, then, than to assign one chassis or deck to each of these functions, using standard rack panels of the required height to provide room for the equipment? After considering the space required, 10½-inch panels for the power supply and modulator and a 12¼-inch panel for the radio frequency stages were decided upon. Five hundred watts in 33¼ inches of rack space—not much need to rent space in the parlor for that.

* 2500 Channing Rd., Cleveland Heights, Ohio.

In developing a circuit for the radio frequency equipment to allow placement on one chassis, several other ideas, which after long years of terrific stress to nerves and pocket-book had become convictions, were incorporated. The first was that a modern transmitter, using modern tubes, should have not more than three stages. Two exciter stages give ample power gain and there need be only three circuits to tune.

Another idea which has taken firm hold is that the crystal frequency should not be doubled more than once to obtain the output frequency. Anything more leads to circuit and space complications and with the high-frequency crystals available at the present time it appears cheaper and certainly simpler to buy a crystal for an additional band than to build in another doubler stage with its additional circuit to be tuned. With three stages and doubling only once, it is possible to operate in four bands with two crystals. If in doubt on the economics of this, sit down and figure what the parts for an additional doubler or doublers will cost, also the cost of increased capacity of the power supply, and add in your time consumed in tuning and pruning the stage at what you think your time is worth—not the figure the boss sets. Balance the total against the cost of a crystal—is it worth it?

500 Watts—Voltage and Current?

With that all settled, but before we can proceed to the selection of the tubes, the question of desirable power supply voltage and current must be settled as that in part will

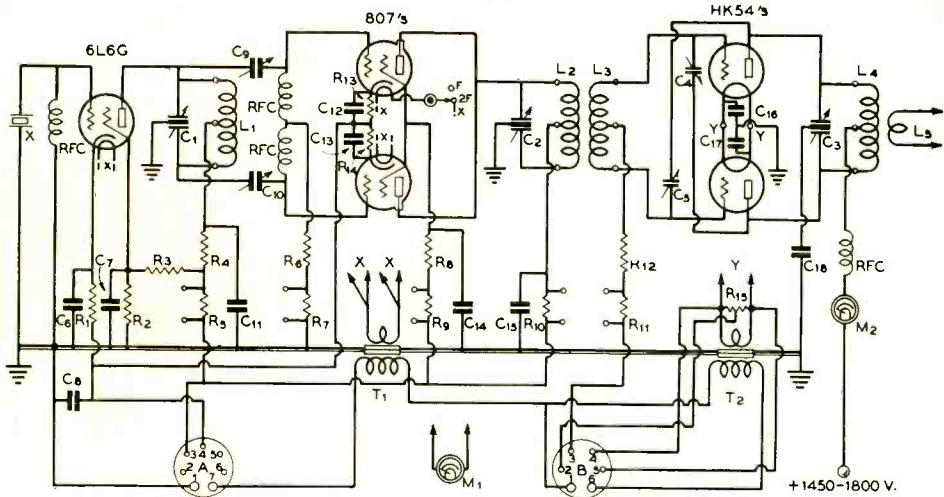

Figure 2.—General wiring diagram of the r.f. section.

C ₁ , C ₂ —100- μ fd. per section midget	μ fd. mica	R ₁ —2500 ohms, 20 watts	R ₁₃ , R ₁₄ —300 ohms, 10 watts
C ₃ —100- μ fd. per section, 4000-volt	C ₁₁ —0.01- μ fd. mica	R ₇ —100 ohms, 1 watt	R ₁₅ —100 ohms c.t., 10 watts
C ₄ , C ₅ —Neutralizing condensers	C ₁₅ —0.01- μ fd. 1000-volt mica	R ₈ —6000 ohms, 2 watts	T ₁ —6.3 v., 3 a.
C ₆ —0.0005- μ fd. mica	C ₁₆ , C ₁₇ —0.002- μ fd. mica	R ₉ —100 ohms, 1 watt	T ₂ —5 v. c.t., 13 a.
C ₇ —0.01- μ fd. mica	C ₁₈ —0.001- μ fd. 5000-volt mica	R ₁₀ —20,000 ohms, 20 watts	RFC—2.5 mh., 125 ma.
C ₈ —0.001- μ fd. mica	R ₁ —500 ohms, 10 watts	R ₉ , R ₁₀ , R ₁₁ —100 ohms, 1 watt	RFC—2.5 mh., 1000 ma.
C ₉ , C ₁₀ —50- μ fd. midgets	R ₂ , R ₃ —15,000 ohms, 10 watts	R ₁₂ —2000 ohms, 10 watts	M ₁ —0-200 ma.
C ₁₁ , C ₁₂ , C ₁₃ —0.02-			M ₂ —0-300 ma.

determine the tube type for the final amplifier. Now 500 watts can be obtained in a number of ways. The book says 500 watts = some volts \times some amperes. We are not exactly limited in the choice of how many volts or amperes are to be used. We might choose a combination of 500 volts and 1 ampere and find ourselves paying \$12.50 each for some 872 rectifiers, or we might choose 5000 volts and .1 ampere and find ourselves buying four 866-A rectifiers at \$2.50 each and plunking down many additional pieces-of-eight for transformers, chokes and condensers.

Having purchased and built considerable quantities of such items since the days of the UC-490 condenser, the writer has had time to form the opinion that it is cheaper to obtain your 500 watts at about 1600 volts and 300 milliamperes than at any other combination.

Tube Lineup

Keeping all these specifications in mind, including the fact that the transmitter must operate on the 3.5-, 7-, 14- and 28-megacycle bands, these tubes were selected: a 6L6G oscillator, a pair of 807's as buffer-doubler, and a pair of HK-54's in the final amplifier. The wiring diagram is shown in figure 2. The

circuits are all conventional in themselves but the combination may be somewhat unusual. The crystal oscillator is a Jones circuit, used here simply because it behaved better with a 20-meter crystal. It is always operated straight through on crystal frequency and there is no difficulty with excessive feedback. We decided to double only once and that function is adequately taken care of by the 807's.

The oscillator is capacity coupled to the 807 stage, which is normally connected as a push-push frequency doubler. For straight through crystal frequency operation the heater of one of the 807's is turned off, thereby causing this tube to act as a neutralizing condenser for the other 807, which then operates as a straight amplifier. Keying is accomplished by breaking both the oscillator and buffer cathode circuits.

The Push-Pull 54 Final

For coupling to the HK-54 amplifier, resort was made to our old friend unity coupling to avoid the additional condenser needed for link coupling. With all the r.f. circuits on one chassis there was no room for the additional grid tuning condenser. If the number of turns on the grid coil is properly adjusted, unity coup-

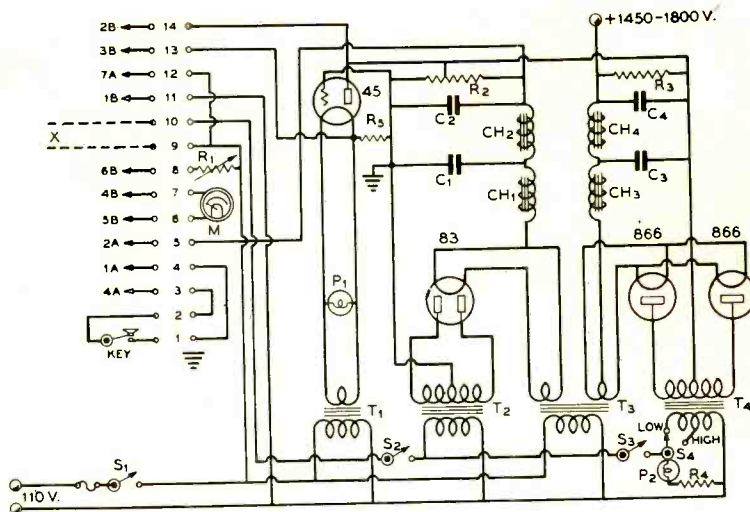

Figure 3.—General wiring diagram of the power supplies.

C₁, C₂—2- μ fd. 1000-volt oil filled
 C₃, C₄—2- μ fd. 2000-volt oil filled
 R₁—50-ohm 50-watt rheostat
 R₂—25,000 ohms, 75 watts
 R₃—50,000 ohms, 100 watts

R₄—1000 ohms, 10 watts
 R₅—2 megohms, 1 watt
 T₁—2.5 v., 3 a.
 T₂—1320 v. c.t., 250 ma.
 T₃—5 v., 3 a.; 2.5 v., 10 a.

T₄—4250 v., c.t., 300 ma. (with tapped primary)
 CH₁—5-20 hy., 200 ma.
 CH₂—12 hy., 200 ma.
 CH₃—5-20 hy., 300 ma.
 CH₄—12 hy., 300 ma.

M—0-10 v., a.c.
 P₁—2.5-volt pilot lamp
 P₂—6.3-volt, 150-ma. pilot lamp
 S₁, S₂, S₃—S.p.s.t. toggle switch
 S₄—D.p.d.t. toggle switch

ling can be as efficient as link coupling. It certainly is in this case, as the HK-54 grids can be overdriven on all bands.

The plate circuit of the HK-54 final is conventional. The output is taken off by means of a link which can be used to feed an untuned line or to couple to a separate antenna tuning tank circuit.

All this is on one deck; a 12 $\frac{1}{4}$ " x 19" panel and a 17" x 13" x 2" chassis with some space to spare as shown by the photo, figure 3. The transformer in the corner is the HK-54 filament transformer, the 6.3-volt transformer for the other stages being under the chassis. The important thing to note about this layout is the symmetry and balance to ground of all stages, the center line and ground point of each stage and tuned circuit being on a line parallel to the panel. This facilitates short leads and probably increases efficiency on the higher frequencies.

The front view of this panel appears in figure 1 and shows on the left the oscillator tuning condenser, center buffer tuning and on the right the final tuning dial. The left-hand instrument is a 0-200 milliammeter and is switched into oscillator, buffer plate and grid, and final grid circuits by the switch

below. The right-hand instrument is a 0-300 milliammeter in the final amplifier plate circuit. The switch below it is used to disconnect the heater circuit of one 807 when doubling is not desired.

The wiring of the high- and low-voltage power supplies is shown in the main wiring diagram. The low-voltage supply uses an 83 rectifier and supplies 500 volts at 200 ma. through a two-section choke-input filter. The high-voltage supply furnishes either 1800 or 1450 volts d.c. at a maximum of 300 ma., also through a two-section filter. This latter supply could also use a slightly lower voltage, 500-ma. transformer in case a separate supply for a modulator is not desired.

Ample switches are provided for control of the transmitter, the switches being connected so that the proper sequence of operations in starting up the transmitter is assured. A pair of terminals are also carried to the rear terminal block so that a remote switch may be used to cut off the power supplies during standby periods. If such a switch is not used the terminals can be jumpered.

The Biasing System

The special feature of the power supplies

is the method of obtaining bias voltage for the final amplifier without a separate supply. As will be seen, the negative of the low-voltage supply is placed below ground by the amount of the desired bias, 180 volts. This idea is not especially new. But combined with this is a type-45 regulator tube connected so that changes in grid current do not upset voltages on the low-voltage bleeder.¹ The tube also holds the bias voltage essentially constant with respect to changes in grid current. Actually the grid bias increases only about 20 volts from zero to 60 milliamperes of grid current and there is no change at all in the bleeder current.

The 45 tube acts as a variable resistance grid leak, adjusting its internal resistance automatically by means of its grid voltage; so the product of this internal resistance and the grid current is equal to 180 volts. At zero grid current 180 volts bias is applied to the final amplifier through the 2-megohm resistance and the 45 tube is practically cut off by the voltage drop in this resistance. As grid current starts, a current tends to flow in reverse direction through a 2-megohm resistor, reducing the cathode bias on the 45 and dropping its internal resistance to such a point as to allow the final grid current to flow through the 45 tube and produce a drop equal to the desired bias.

Even closer bias voltage control could be achieved by the use of a 2A3 in place of the 45. The total grid current flows through the regulator tube; only the infinitesimal amount passing through the 2-megohm resistor flows through the power supply bleeder. In this way

¹ R. L. Dawley, "Attacking the Bias Problem," RADIO, Jan., 1937, p. 23.

regulated fixed bias is obtained for the final amplifier without a separate bias supply with its attendant cost and space requirements.

Power Supply Mounting

The power supply equipment is mounted on another 17" x 13" x 2" chassis behind a 10½-inch panel which carries the switches, pilot lights, a filament rheostat for the HK-54's, and a 0-10 voltmeter to measure this voltage. Terminals are brought out at the rear for leads to the r.f. chassis and a socket is provided for a.c. input and a line fuse, always a good safety precaution.

Modulator Provision

The middle panel and chassis of the transmitter consists of another 10½" x 19" panel and 17" x 13" x 2" chassis which is reserved for the modulator and modulator power supply, which were not desired at the time the rest of the equipment was built. A pair of TZ40's should be capable of modulating with speech the input of about 400 watts which can be used on phone. The input must be dropped by means of the high-low power transformer switch, reducing the plate voltage to 1450, since the rating on the HK-54's is 1500 volts for modulation. There is ample room on this chassis for the equipment and if desired the driver tubes could be included.

The Cabinet Rack

The three black wrinkle-finished panels are assembled in a sectional cabinet rack painted slate gray wrinkle, giving a very pleasing contrast. The grill for viewing the final amplifier tubes is made of polished aluminum strip. This and the polished metal switch plates

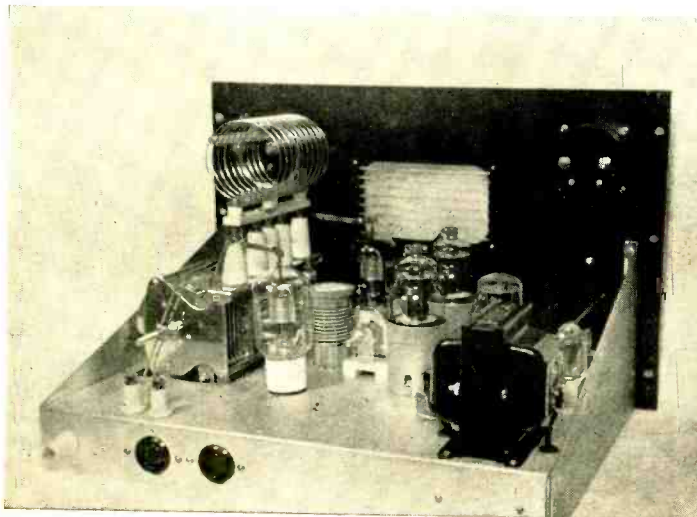

Figure 3. Rear view of the r.f. chassis. The large transformer to the right rear of the chassis supplies filament power to the 54's in the final.

complete the "dressing up" of the transmitter. To the writer this grill is another highly important point because with small tubes operating at high efficiencies, but still near the point at which a maladjustment might cause the plate to start to drip, it seems desirable to know what is going on behind the panel. Evolution not yet having provided us with the neck of a giraffe for looking around the back of the rack, a hole in the front panel seemed the logical solution and the grill keeps fingers and noses from harm.

Notes on Operation

The transmitter is used with two crystals, 3.5 and 14 Mc., to operate in all four bands, 3.5, 7, 14 and 28 Mc. It is possible to obtain 60 or more milliamperes grid current on the final amplifier, which is more than sufficient to drive the final tubes up to 250 or 300 milliamperes plate current. This is possible with either one or both 807 tubes in service; that is, straight through on crystal frequency or doubling to the second harmonic.

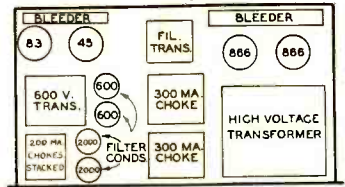
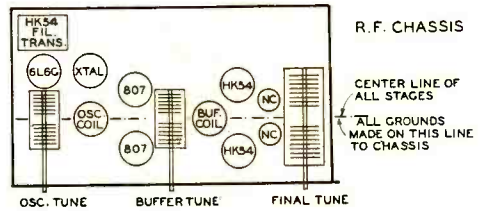

Figure 5. Layout drawing of the two chassis showing how the parts are arranged in the r.f. and power supply sections.

So once again we ask the three questions at the beginning of this article and we reply —Why?

COIL DATA					
Coil	Diameter	3.5 Mc.	7 Mc.	14 Mc.	28 Mc.
L ₁	1½"	38 turns no. 26 c.c.	22 turns no. 18 enam.	10 turns no. 16 enam.	—
L ₂	1½"	38 turns no. 26 c.c.	22 turns no. 18 enam.	10 turns no. 16 enam.	6 turns no. 16 enam.
L ₃	Wound between turns of L ₂	30 turns no. 26 c.c.	18 turns no. 20 c.c.	8 turns no. 20 c.c.	5 turns no. 20 c.c.
L ₄	2¾"	34 turns no. 16 enam.	22 turns no. 14 enam.	10 turns no. 14 enam.	6 turns no. 12 enam.
L ₅	Output link	2 turns	2 turns	2 turns	2 turns

L₄ and the link L₅ are standard manufactured plug-in coils.

Figure 4. Under-chassis view of the r.f. section. The meter switch is mounted upon the panel to the left front; the 6.3-volt filament transformer is mounted on the left rear drop of the chassis.

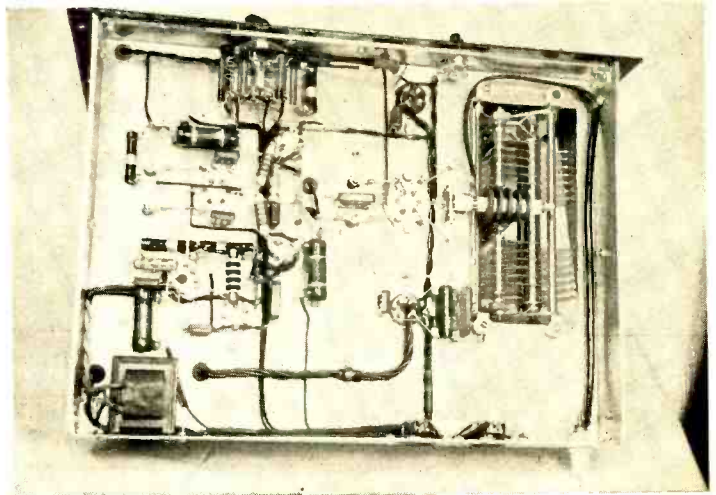



Experimental ionosphere measurement transmitter as installed at West Virginia University.

PULSING AMATEUR TRANSMITTERS

for Ionosphere Sounding

By ALBERT WILEY FRIEND,*
W8DSJ

The first necessity in the development of ionosphere sounding equipment as an addition to an amateur station is the equipment for keying the transmitter so as to send out short pulses of carrier wave of uniform amplitude

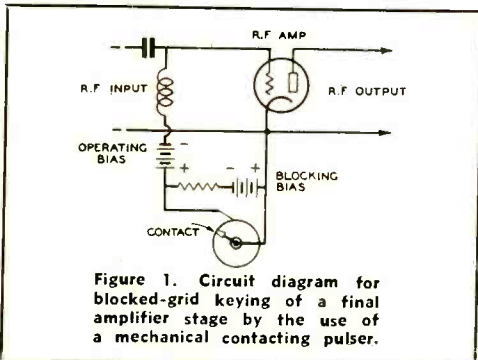

and spacing. When this project is completed it will not require a great deal more work before the actual reflections from the ionosphere can be observed and the layer heights measured at will. Then the sporadic E reflections may be detected and ultra-high dx possibilities will be known to the investigator.

For general ionosphere work the length of the pulses of signal emitted should lie between 100 and 500 microseconds. In order to prevent the reaction of high-Q circuits upon these short pulses the keying or modulation stage should take place in the final amplifier stage. Generally it will be found that this control can best be provided by application of a pulse-generating or keying device to the *grid* circuit of the amplifier stage. Between pulses this

* Assistant Professor, West Virginia University, Morgantown, W. Va., W8DSJ, W8KIU, W8XNR, W8XAW.

Last month we presented by the same author a general discussion of the ionosphere and the value of ionosphere soundings. This installment describes how an ordinary amateur transmitter may be used to make these soundings, which experimentally minded amateurs should find an interesting and fertile field for research.

grid must be sufficiently biased to prevent any flow of plate current. This high bias may also be used to help prevent spurious pulse emission.

The Mechanical Contactor Pulsar

The mechanical keying device, being perhaps the most obvious type, should be considered first. Figure 1 shows the circuit diagram for using the contactor in conjunction with grid blocking. The resistor R in series with the blocking bias should be of approximately 25,000 to 250,000 ohms so as to limit the contact current to moderate values and prevent arcing.

The contact disc must be driven by a synchronous motor so as to provide uniformly spaced pulses. Any synchronous speed may be used, but 3600 r.p.m. is preferable due to the smaller diameter disc which may be used for a given pulse length. The 3600 r.p.m. motor, by providing 60 pulses per second, also makes possible a bright trace on the receiving oscilloscope screen. A hard fibre sheet of about $\frac{3}{8}$ or $\frac{1}{2}$ inch thickness may be turned on a lathe, and a hard copper slug of wedge shape fitted into a slot on the periphery to make the contact wheel. A fine wire lead from the contact slug to the hub will provide electrical contact to the motor frame via the bearings in the motor. The oil film in the bearings seems to give no trouble at all. Figures 2 and 3 illustrate the general method of construction and the mounting of the contacts. The calculation of the length of pulse in seconds may be made by the use of the formula:



Figure 2. A simple model of the mechanical pulsar. The spring-brass stationary contact may be seen screwed to the wooden base.

$$T = \frac{(a + b)60}{(\text{r.p.m.})\pi D}$$

where:

- T = time of contact in seconds
- a = width of contact on disc
- b = width of fixed contact
- (r.p.m.) = speed of rotation of disc in revolutions per minute
- D = diameter of disc in same units as a and b
- $\pi = 3.1416$.

While this mechanical contactor has given excellent service for over one hundred million contacts without adjustment, there are many and various pulsing devices of both mechanical and electronic types which are capable of just as good or better service. Figure 4 shows

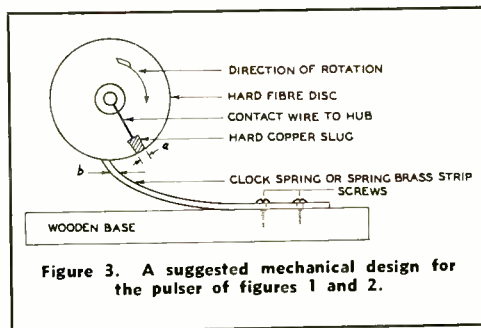

Figure 3. A suggested mechanical design for the pulsar of figures 1 and 2.

a sketch of a practical pulsing contactor utilizing a conducting fluid such as very dilute sulphuric acid in a self-pumping rotating-nozzle spray device. For best operation one nozzle only should be open, since two streams are difficult to synchronize.

With care in construction the pulse length may be reduced to one hundred microseconds or less if desired. The contact wire which cuts through the liquid jet should be a fine platinum (or other noncorrosive) wire. The body of the rotating centrifugal pump and the nozzle may be machined from brass rod and tubing.

A combination mechanical-electrical pulsar may be constructed as indicated in figure 5.

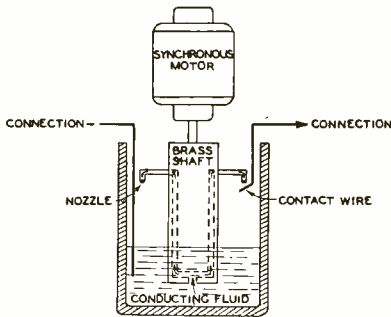

Figure 4. A pulse contactor using a stream of conducting fluid for making the contact. A dilute solution of sulphuric acid, such as battery electrolyte, should be used.

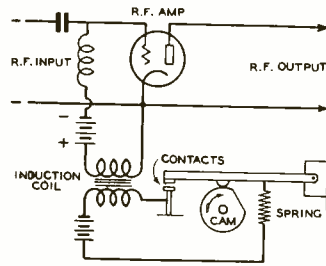

Figure 5. In this circuit the blocking bias on the r.f. amplifier is bucked out by the voltage induced in the secondary of the induction coil when the primary circuit is broken by the cam and contacts.

The use of a cam with breaker contacts driven by a synchronous motor, may be used to produce surges in the secondary of a common induction coil so as to oppose the blocking bias on a final r.f. amplifier stage. Correct polarization of the secondary is essential in order to cause the maximum surge of potential to oppose the bias. A cathode-ray oscilloscope is an excellent indicator for determining the operation of these devices. Care in adjustment will eliminate any extra pulses which may appear due to irregular contacting and bouncing of the breaker arm. Careful spring adjustment is essential to perfect performance.

The Telephone Magneto Pulser

The usual amateur junk heap may yield an excellent pulse generator in the form of an

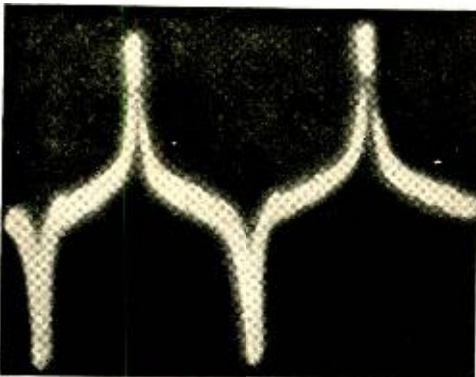

Figure 6. Photograph from the screen of a cathode-ray oscilloscope showing the waveform of the voltage from a telephone magneto.

old telephone magneto. If a unit having a wave form similar to that shown in figure 6 (as viewed on an oscilloscope) can be found, the crank and gear mechanism may be removed and a synchronous motor drive substituted in its place.

The output wave will then be synchronized with the power line frequency. The only operating difficulty found in practice has been in the adaptation of the bearings for continuous operation. This trouble was eliminated by the installation of a wick oiling system using long rifle cartridge shells as reservoirs and oiling wicks of heavy cotton yarn. If the existing contacts prove to be inadequate, a new set of slip rings may be easily constructed from small wheels or metal rings. Figure 7 is a photograph of a working model constructed from a Stromberg-Carlson telephone magneto removed from an old telephone.

Figure 8 is the circuit diagram of connections to the transmitter. The potentiometer *R* across the magneto output should be of high enough resistance to avoid overloading the magneto which may cause its output voltage to drop severely; 50,000 to 100,000 ohms is generally quite satisfactory.

The blocking bias in the grid circuit must be of sufficiently high value to allow only the upper one-third or one-half of the magneto wave to cause operation of the transmitter. The emitted pulses of carrier should have a time duration of about 750 microseconds when a 3600 r.p.m. motor is used or about 1500 microseconds in the case of an 1800 r.p.m. motor.

If a reduction in pulse length is desired a distorting vacuum tube amplifier may be added as shown in figure 9. The grid bias on the distorting amplifier should then be far beyond cutoff so as to cause operation on only the maximum peak of the magneto output potential. Perhaps only the upper ten per cent of this wave may be utilized. The pulse length may thus be reduced to about 250 microseconds when the magneto is driven at 3600 r.p.m.

Gaseous Triode Pulsing

In general the most satisfactory of all pulse generators is the electronic type using mercury vapor or gaseous triodes. The synchronized saw-tooth wave generator used for producing the linear sweep in most cathode-ray oscilloscopes is very closely related to one type of variable rate electronic pulse generator. This is the common relaxation oscillator using a gas filled triode and adapted for pulse output instead of the saw-tooth waveform. Figure 10 is an example of an adaptation of this circuit to the pulsing of a final r.f. amplifier.

The d.c. power source P is a low current source of not less than 500 volts which charges the condenser C at a rate which is inversely proportional to the product $(R_2 + R_3)C$. When the potential across C becomes greater than the ignition potential of the gaseous triode T, the condenser discharges through R_1 and the triode. This produces a pulse of voltage across R_1 which is in series with the grid circuit of the r.f. amplifier. The pulse polarity is arranged to buck the blocking bias during the discharge period and so cause the emission of a pulse of r.f. carrier in the output. The length of each pulse is proportional to the product R_1C . If only the highest 63 per cent of the pulse voltage is capable of unblocking the amplifier then the pulse length in seconds will be equal to R_1C when R_1 is in ohms and C is in farads (viz: microfarads divided by one million). For most gen-

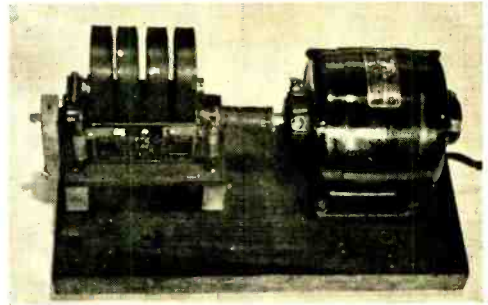

Figure 7. Synchronous motor driving a Stromberg-Carlson telephone magneto. The shaft coupling is a piece of air hose. Added carbon brushes and the slip ring may be seen on the left end of the shaft. The rifle-cartridge oil reservoirs are on the front corners.

eral ionosphere sounding work C should be $0.03 \mu\text{fd.}$ and $R_1 = 1000$ to 5000 ohms. R_3 is used to control the rate of pulsing. The power frequency may be introduced from a filament transformer winding connected to the synchronizing terminals. Then the setting of R_3 will determine whether the rate of pulsing is to be the same as the power line frequency or some fraction thereof.

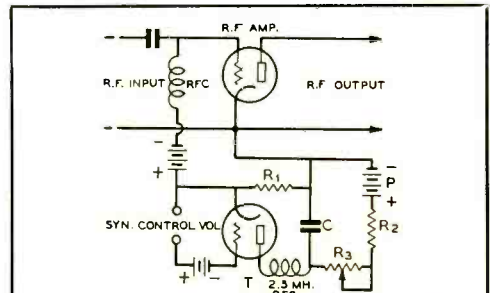

Figure 10. A pulse generator of the relaxation oscillator type connected to control an r.f. stage in the grid circuit.

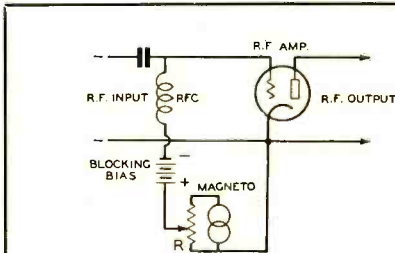

Figure 8. Circuit diagram showing the method of connecting the magneto pulse generator to an r.f. amplifier stage.

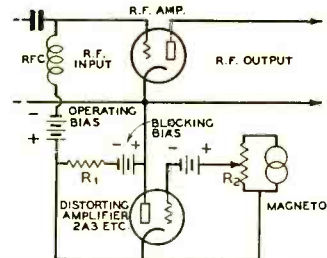
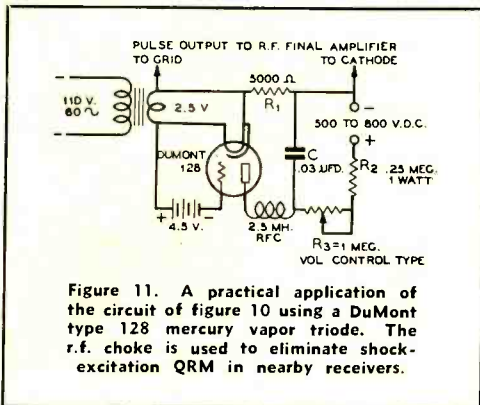

Figure 9. The magneto pulser and distorting amplifier connected to an r.f. amplifier stage.



A type 128 gaseous triode with 700 volts charging potential, $4\frac{1}{2}$ volts grid bias and 2.5 volts synchronizing potential will easily pulse any ordinary amateur high- μ triode or pentode final amplifier stage. Figure 11 illustrates an experimental pulser using the 128 tube. If desired for some reason a larger tube such as the KY-21, KU-627 or FG-17 may be used.

While the variable rate pulser of figures 10 and 11 is quite satisfactory for most purposes, there is some trouble due to extra pulses unless care in adjustment and synchronization is exercised. In order to provide relief from this defect, a fixed rate pulse generator has been designed. The pulse rate is equal to the power line frequency. In most localities this is 60 cycles per second.

In figure 12 the circuit diagram for this locked synchronization pulser and its connection to the final amplifier are shown. The sequence of operation follows: When the plate of the diode rectifier becomes positive, conduction takes place and the condenser C is charged as shown. At the same time the grid of the gaseous triode T is made more negative by the potential of the low voltage winding L.V. which is connected 180 degrees out of phase with the high voltage winding H.V. This prevents the triode T from conducting while the condenser C is charging. When the next alternation occurs, the diode fails to conduct and the potential of the low voltage winding L.V. bucks the grid bias of the gaseous triode T causing conduction to take place and the condenser C to discharge through the resistor R. This discharge takes place suddenly when the gas in the tube ionizes. The sudden rise of current produces a sharp pulse of voltage across the resistor R. This pulse bucking the block bias of the r.f. amplifier causes the carrier pulse to be produced. There is no possibility of multiple

pulses occurring due to the fact that the discharged condenser C cannot be charged again until the cycle is repeated from the beginning.

As in the relaxation oscillator of figure 8, a type 128 tube may be used if H.V. = 600 v., L.V. = 2.5 v., $R = 5000$ to 1000 ohms, $C = 0.03 \mu\text{fd.}$ and the bias on tube T = 4.5 volts. Figure 13 shows a top view photograph of an experimental model of this pulser. In figure 14 is shown a complete transmitter using the same pulser with an RK-28 r.f. final amplifier and a 6F6 crystal oscillator. The r.f. portion of the circuit is quite conventional in every respect except for the connection of the RK-28 grid return to the pulser and blocking bias supply. In the bias supply the switch SW has two indicated positions P and T. Position P represents the pulsing position and T the tuning position. The condenser C_p must be of the best quality having a working voltage rating not less than 1000 d.c. in order to prevent breakdown due to the severe transient effects due to the mechanical vibration caused by the surges of attraction between the oppositely charged plates of the condenser. The r.f. chokes in the grid and plate circuits must also be first quality equipment in order to prevent the continued mechanical attraction hammering effect between the pie sections during pulsing from causing the entire winding to drift toward the center of the supporting rod. The size of these chokes should be about 2.5 to 10 millihenries each.

In the pulser circuit a type 27 tube is shown as a rectifier. Since the current drain of the unit is very small, almost any common tube may be connected as a diode for rectifier service. Since our available transformer had two 2.5-volt windings and type 27's were quite

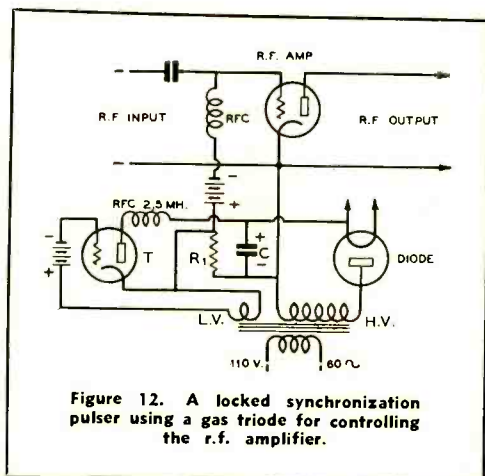

plentiful, they were used. The 128-A or 128 type tubes are readily available as replacement tubes for cathode-ray oscillographs. They have a much higher voltage rating than the type 885 gas triode, which makes possible their use without any amplification of the pulse output. The older type (128) is preferable for service in any case where the peak transformer voltage (1.414 times the r.m.s. or effective value) approaches 1000 volts. *In any case the constructor must be certain that the grid control voltage on the pulse tube is on the negative alternation when the plate of the rectifier tube becomes positive* (i.e. the grid control winding must be 180° out of phase with the high voltage winding). Failure to observe this precaution will most likely cause destruction of the pulse and rectifier tubes. The grid bias on the 128 should be adjusted to as high a value as necessary to prevent flashing over during the condenser charging alternation. The 4.5 volts specified is correct for the type 128 but a slightly higher value may sometimes be required for the type 128-A tube. If this grid bias is increased it will be found advantageous to increase the 60-cycle firing voltage on the grid above the 2.5-volt value supplied by the heater circuit (2.5 to perhaps 25 volts may be used if desired).

The pulses of plate current drawn by the RK-28 make it necessary to shunt the plate milliammeter with a by-pass condenser to pro-



Figure 13. An experimental model of a pulse generator using the circuit of figure 12.

tect the meter windings. A shorting switch may be used across the meter for the same purpose during pulsing since the average d.c. current is too small to be read in any case. In some instances the plate current pulses may set up damped parasitic oscillations in the power supply and r.f. choke circuits. These may be detected by careful testing with a cathode-ray oscilloscope having a wide-band input amplifier connected to a six-foot antenna placed in the vicinity of the plate circuit. Their cure is the insertion of a 100,000-ohm two-watt resistor in series with the plate r.f. choke, with a shorting switch for removing this resistor from the plate circuit during tuning adjustments when full plate current is

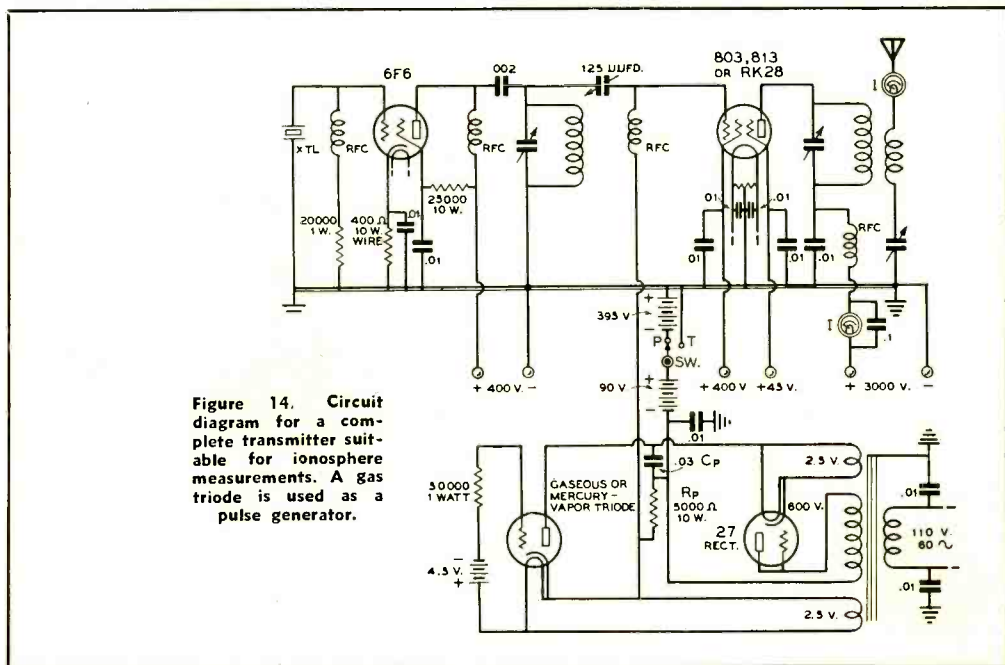

Figure 14. Circuit diagram for a complete transmitter suitable for ionosphere measurements. A gas triode is used as a pulse generator.

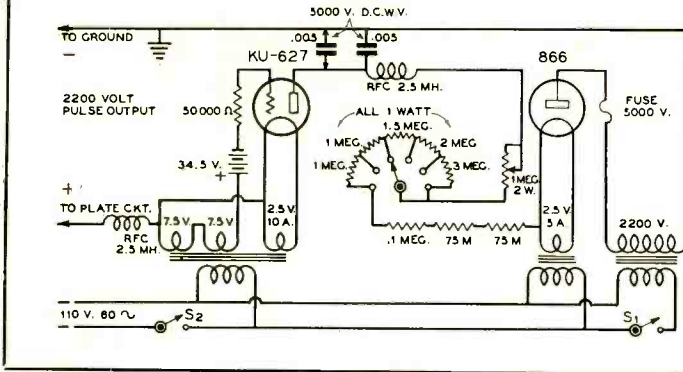

Figure 15. Circuit diagram of a high voltage pulser suitable for pulsing a transmitter in the plate circuit.

drawn. If a grid current meter is used for the RK-28, it must be removed or short circuited during pulse operation.

If any spurious or parasitic pulses appear after the main pulse has been emitted they are always of very small amplitude as compared with the main pulse, and may always be removed from the r.f. output by increasing the grid blocking bias on the RK-28. In a few cases of extra pulses due to maladjustment, a slightly higher grid bias on the 128 tube may be desirable.

Plate Pulsing

For those who do not relish the idea of altering the grid circuit of the transmitter a high voltage plate circuit pulser is in order. One of these has been constructed using a type KU-627 mercury-vapor triode operating from a twenty-to-one voltage step-up transformer. This gives a peak plate voltage of about 3000 when operated from the 110-volt a.c. line.

High voltage types of G.E. thyratron tubes would be just as satisfactory as the tube used in the tests. Also, the type KY-21 will prove to be quite useful in this service.

The circuit diagram of the pulser using the KU-627 is shown in figure 15. The operation is the same as the relaxation oscillator type pulsers of figures 10 and 11. The variable one-megohm resistor, and the tap switch resistance, control the rate of pulsing between the limits of 60 per second and about two per second. **These controls are HOT at 3000 volts peak so they must be carefully insulated so as to prevent death or injury to the operator.** The filament transformers must be insulated to stand not less than 3500 volts and the bias battery must be mounted upon insulation to withstand the same voltage or more. In figure 15 it may be seen that every lead in the unit except the 110-volt primary lines and the ground (negative pulse) lead is

at the full 3000 volts. **DO NOT TOUCH A SINGLE PART WHILE THE SWITCH IS CLOSED IN THE "ON" POSITION.**

This pulser is designed for connection in place of the regular plate power supply on any transmitter. The only requirements are that the antenna should be tightly coupled to the plate circuit, the plate milliammeter must be heavily by-passed or shunted during pulsing and the plate blocking condensers should not be larger than 0.001 μfd. total to ground. Spurious pulses coming after the main pulse may be eliminated when of the usual minor nature by using higher grid bias on the final or by the use of a reverse potential bucking battery in series with the connections to the pulser.

The pulse length when working into a final presenting a 5000-ohm impedance is

[Continued on Page 82]

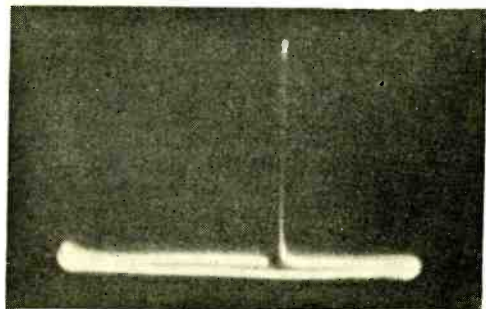
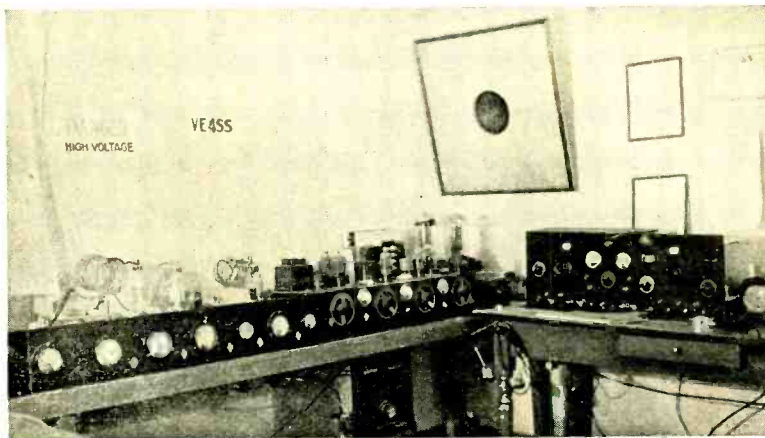

Figure 16. The cathode-ray pattern of a high voltage pulse superimposed on a 60-cycle sweep. The pulse was introduced into the oscilloscope through a short piece of wire placed near the pulser output. The amplifier in the oscilloscope broadens the pulse somewhat, a much sharper pulse being shown on the screen when the output of the transmitter is coupled directly into the oscilloscope plates.

A description of an inexpensive and easily constructed transmitter control system which gives positive time delay, push-button control, adjustable protection and automatic reset of the overload circuit.



PUSH-BUTTON CONTROL

for Transmitters

Now that everything from starting the car to tuning the h.c. receiver and rotating the signal splasher can be controlled by push buttons, there is an apparent need for an inexpensive arrangement for effective transmitter control by means of push buttons. The circuit to be described has proved to be the solution to the problem in the case of this station. It is the result of many months of experimenting and resetting the usual latch types of overload relays, of blowing countless fuses, and of frenzied rushing to the control switches when something arced over. With this circuit in use it has become a pleasure to operate a high-powered phone transmitter, due to the simplicity of operating controls and to the greater margin of safety.

Although the control arrangement utilizes only two inexpensive relays and a few small parts such as push buttons and resistors in

By

A. G. SHEFFIELD,*

VE4SS

addition to the regular transmitter bias pack, it has a number of features commonly found only in much more complicated and expensive setups. Briefly, the control circuit has the following features: (1) touch button 1 to turn transmitter on; (2) touch button 2 to turn transmitter off; (3) widely adjustable overload protection which is instantly reset by pressing "on" button again; (4) electrical protection of transmitter in case of bias pack

* 135 Sunnyside Blvd., St. James, Winnipeg, Man., Canada.

failure through relay B; (5) time delay protection by holding off high-voltage primary—even if “on” button is operated—until relay B operates when bias rectifier tube (83v) comes up to operating temperature.

The sequence of operation of the control circuit is comparatively simple and may be described as follows: First, make sure that the safety switch, S, in the primary circuits of the high-voltage transformers is open. Then, when the main power switch to the transmitter is turned on the filaments of all tubes will light and power will be applied to the heater of the 83v. When this tube comes up to operating temperature relay B will close due to the flow of the bleeder current of the bias pack through it. However, the transmitter will not be turned on since the safety switch is open. Then if the “off” button is pressed once, the holding circuit of relay A will come into action and this relay will close, thus opening relay B and preparing the circuit for normal operation. Then, if the safety switch is closed, pressing the “on” button will put the transmitter on the air.

The operation of the circuit when the “on” button is pressed is as follows: Pressing button 2 breaks the holding circuit of relay A and allows the relay to open. As it opens, contacts 3 and 4 will close, completing the circuit from the low end of the bleeder through relay B to ground. Relay B will then close, bringing contacts 5 and 6 together to apply the primary power to the plate transformers of the transmitter.

From the above sequence it can be seen that push button 2 is not standard in that it is of the *normally closed* type instead of normally open. Push button 1, however, is of the normally open type. When this latter button is depressed (the “off” button) contacts 1 and 2 of relay A, the holding contacts, are shorted for an instant and this relay closes and holds closed. This opens the circuit between contacts 3 and 4, opens the bleeder current circuit through relay B and this relay opens, thus breaking the 110-volt circuit to the primaries of the transmitter through contacts 5 and 6.

Overload Circuit Operation

If the high-voltage circuit should become shorted or overloaded by any abnormal condition (such as the tank circuit being off resonance, tank circuit flashover, blown filter or by-pass condenser, or any other cause that would draw more current than R_1 is set to shunt around L_1 of relay A) the d.c. flowing from the c.t. of the high-voltage transformer to ground would pass through the parallel circuit of R_1 and L_1 and thus cause the arma-

ture of this relay to move. This would close contacts 1 and 2, thus energizing the holding coil L_2 of relay A, closing this relay and opening relay B to remove the plate voltage from the transmitter. Pushing the “on” button will open this holding circuit and the power will come on again.

Actually, the action described above takes place very rapidly; in practice a tank condenser flashover can overload and be reset during a QSO with no noticeable interruption. When adjusting the circuit for rapid operation a careful adjustment of R_1 must be made. This rheostat is best turned to a low value when tuning up the transmitter and then adjusted to an operating current slightly more than the normal current drain of the transmitter. It can be set close enough to the normal current of the rig to shut the transmitter down whenever one of the boys with their “Arco” sparking pencils attempts to draw an arc from the final tank coil, and yet it will not stop the transmitter under any of the normal variations in plate current that are experienced while operating.

The overload protection of this circuit alone will prove to be well worth the cost of the installation of the control system; what ham hasn't made a mad dash, too late, for the control switch when fireworks start shooting from the rig? Relay B is not inherently a portion of the control and overload circuits, but its use is desirable especially if a large amount of power is to be handled. Also, the load upon the bias pack during standby periods is lightened by its use, and the additional features of time delay and protection from operation of the transmitter when the bias pack is inoperative are well worth while.

The coil of relay B, L_2 , operates from the bleeder current of the bias pack and therefore any failure of rectifier tubes or filter condensers or any other piece of equipment that would result in no bias voltage will keep this relay from closing. Hence, it is impossible to apply the plate voltage under this condition. There is another valuable feature of this arrangement of using the bleeder current of the bias pack to operate the “power on” relay. Since the bleeder return circuit is opened by contacts 3 and 4 of relay A when the transmitter is turned off, the tubes whose grids are operating from this pack get a much larger bias voltage when they are standing by than when they are normally operating. This high bias stops any tendency toward an annoying a.c. hum that may appear on the receiver when the transmitter is standing by; this condition is noticed on many transmitters when the rig is not on the air but the filaments are lighted.

This overbiasing arrangement during standby periods was an easy way to stop this filament hum in several stations when it could not be eliminated by normal methods. This arrangement also reduces the load on the bias rectifier during standby periods, the time when the load is normally heaviest, by opening the bleeder circuit. This will give longer tube life and generally lighten the load on any bias pack without altering the operation or voltage when the transmitter is in operation.

Constructional Details

The two relays employed in the control system are easily constructed from the units taken from A-B eliminators and trickle-charger control units of the type used some ten years ago. A few of these relays are generally found around every ham's junk box, or they may be obtained quite inexpensively from a radio parts dealer handling used apparatus. If desired, those who wish to purchase new relays may obtain a double-pole double-throw one for use at A, and single-pole single-throw one for B; in either case, however, relay A will have to be rewound as follows:

Relay "A"

The coil L_2 of this relay is wound on the core and is simply no. 34 to 38 enameled wire wound until the coil form is nearly full; this coil can be from 500 to 1500 ohms d.c. resistance. Leave room for winding L_1 on top. The number of turns required for L_1 will vary somewhat with the load of the transmitter, but a good average value is about three layers of no. 24 (100 to 150 turns). The amount of current at which the contacts will operate can be adjusted by varying the value of the shunting resistor, R_1 .

Too few turns on L_1 will allow overload operation only at high current values. Contacts 1 and 2 should be set quite close but not touching when the armature is in the non-operated condition, and these contacts must make before contacts 3 and 4 open. If erratic, buzzing operation is encountered with this relay, reverse the connections of either L_1 or L_2 . The fields of these two windings should aid each other. Some adjustment of the operation of the relay may be made by the spring tension, but it is usually best to use only enough tension to keep contacts 3 and 4 firmly closed.

The value of series resistor R_2 is governed by the winding of L_2 . It should be high enough in resistance to prevent heating of the coil and yet low enough so that the action of the relay is positive. Generally a 5-watt resistor

of about 10,000 ohms will be found suitable in this position. It will be found that a drop of about 10 volts across the coil will be required to operate it positively.

Relay "B"

If a similar type of relay to the rewound type used at A is employed, it will be best to wind the bobbin full of about no. 26 enameled wire. When using one of the B-eliminator relays it will be found best to parallel the two sets of contacts for greater current carrying capacity. A standard s.p.s.t. relay with heavy contacts and with a coil resistance of 50 to 200 ohms would probably be better and it would operate without change from the bias-pack bleeder current in any normal installation. Also, one of the conventional a.c. operated power control relays would operate quite satisfactorily in this position; this type of relay runs with unusual quietness when operating on d.c.

[Continued on Page 75]

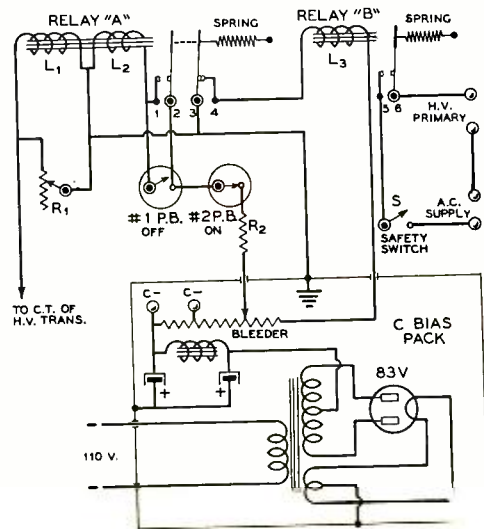

Schematic diagram of the complete control circuit. All armatures and contacts are indicated in the positions they would have with the rig completely disconnected from the line.

- | | |
|--|---|
| L_1 — Approximately 100 turns no. 24 | over 200-ohms res. |
| L_2 — No. 36 enameled wound to fit core. | R_1 — Overload control, 20-ohm rheostat. |
| L_3 — Not critical; not | R_2 — Approximately 10,000 ohms, 5 watts. |

An AMPLIFIER to End All Amplifiers

By TOM PATTERSON. * W6DDX

By making proper provisions, one amplifier can be made to do service for practically every purpose to which an audio amplifier is put around an amateur station. Such a multi-purpose amplifier is described in this article. It is truly "an amplifier to end all amplifiers."

A glance around any amateur radio shack will nearly always disclose several audio frequency amplifiers in various stages of decomposition. They usually range in size from small to large and each will probably be useless for anything other than its own specific (and probably long forgotten) purpose. Such was the case at W6DDX.

* 4215 Eighth St., Riverside, Calif.

The "Amplifier to End All Amplifiers" was born of a desire to remedy this situation by producing *one* multi-purpose amplifier to replace all of the others. We wanted an amplifier to satisfy our amateur radio requirements but also capable of both producing phonograph recordings and playing them back. And in addition to this we wanted broadcast reception with really good quality. With these requirements in mind, everything else in the shack even remotely resembling an a.f. ampli-

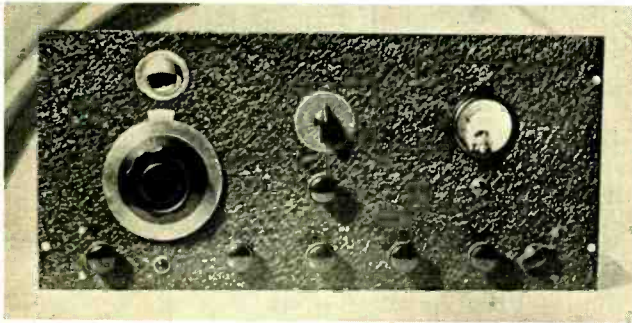
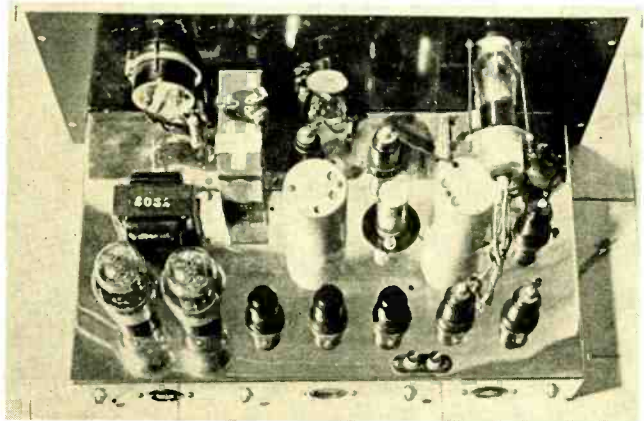
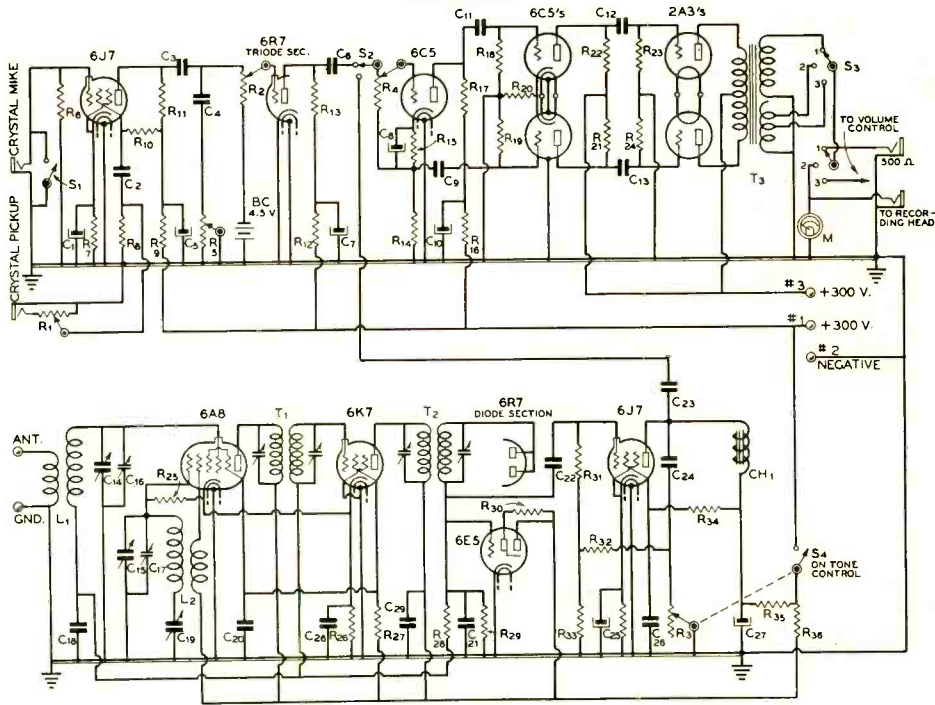

Figure 1. The multi-purpose audio amplifier and the broadcast tuner are constructed on a single chassis. Controls are identified in the text.

Figure 2. Showing layout of parts for the amplifier and b.c.l. tuner.





Circuit of the radio amplifier and broadcast tuner.

- | | | | |
|--|---|---|--|
| C ₁ —25- μ fd. 25-volt electrolytic | C ₂₂ —0.5- μ fd. 200-volt tubular | R ₁₃ —25,000 ohms, 1 watt | R ₃₂ —1 megohm, 1/2 watt |
| C ₂ , C ₃ —0.1- μ fd. 400-volt tubular | C ₂₃ —0.1- μ fd. 400-volt tubular | R ₁₄ —50,000 ohms, 1 watt | R ₃₃ —750,000 ohms, 1/2 watt |
| C ₄ —0.1- μ fd. 200-volt tubular | C ₂₄ —0.2- μ fd. 400-volt tubular | R ₁₅ —2000 ohms, 1 watt | R ₃₄ —2 megohms, 1 watt |
| C ₅ —8- μ fd. 450-volt electrolytic | C ₂₅ —25- μ fd. 25-volt electrolytic | R ₁₆ —15,000 ohms, 1 watt | R ₃₅ —15,000 ohms, 1 watt |
| C ₆ —0.1- μ fd. 400-volt tubular | C ₂₆ —0.1- μ fd. 400-volt tubular | R ₁₇ —50,000 ohms, 1 watt | T ₁ , T ₂ —465-kc. i.f. transformers |
| C ₇ —8- μ fd. 450-volt electrolytic | C ₂₇ —8- μ fd. 450-volt electrolytic | R ₁₈ , R ₁₉ —500,000 ohms, 1/2 watt | T ₃ —Output transformer, 5000 ohms to 500, 15 and 9 ohms |
| C ₈ —25- μ fd. 25-volt electrolytic | C ₂₈ —25- μ fd. 200-volt tubular | R ₂₀ —1000 ohms, 1 watt | CH—High-impedance plate choke |
| C ₉ —0.1- μ fd. 400-volt tubular | C ₂₉ —0.1- μ fd. 400-volt tubular | R ₂₁ , R ₂₂ —50,000 ohms, 1 watt | L ₁ , L ₂ —Broadcast detector and oscillator coils |
| C ₁₀ —8- μ fd. 450-volt electrolytic | R ₁ , R ₂ , R ₃ , R ₄ , R ₅ —500,000-ohm potentiometer | R ₂₃ , R ₂₄ —250,000 ohms, 1/2 watt | S ₁ —S.p.s.t. toggle switch |
| C ₁₁ , C ₁₂ , C ₁₃ —0.1- μ fd. 400-volt tubular | R ₆ —5 megohms, 1/2 watt | R ₂₅ —50,000 ohms, 1/2 watt | S ₂ —S.p.d.t. toggle switch |
| C ₁₄ , C ₁₅ —Two-gang b.c. condenser | R ₇ —2000 ohms, 1 watt | R ₂₆ —200 ohms, 1 watt | S ₃ —Two-pole three-position switch |
| C ₁₆ , C ₁₇ —Mica trimmers on b.c. condenser | R ₈ —100,000 ohms, 1/2 watt | R ₂₇ —50,000 ohms, 1 watt | S ₄ —S.p.s.t. switch |
| C ₁₈ —0.4- μ fd. 200-volt tubular | R ₉ —25,000 ohms, 1 watt | R ₂₈ —1 megohm, 1/2 watt | M—0-1 d.c. milliammeter |
| C ₁₉ —300 to 500- μ fd. oscillator series padder | R ₁₀ —2 megohms, 1/2 watt | R ₂₉ —500,000 ohms, 1/2 watt | BC—4 1/2-v. midget "C" battery or 3 bias cells (3.75 v.) |
| C ₂₀ —0.1- μ fd. 400-volt tubular | R ₁₁ —250,000 ohms, 1 watt | R ₃₀ —1 megohm, 1/2 watt | |
| C ₂₁ —200- μ fd. mica | R ₁₂ —15,000 ohms, 1 watt | R ₃₁ —250,000 ohms, 1/2 watt | |

fier was junked, and one unit, the "Amplifier to End All Amplifiers," was designed and built.

Circuit

The circuit finally evolved is entirely resistance coupled and features push-pull 2A3's in the output stage. The gain of the system is sufficient to work from a sound-cell crystal microphone. The undistorted output of 10 watts is enough to drive a high power modulator, plenty to grid modulate practically anything, and sufficient to plate modulate a low-power transmitter.

Two input channels are provided. In our own case, one is fed by a sound-cell crystal microphone and the other by a crystal phonograph pickup. Mixing of the two, or of any other signal sources of similar impedances and levels, is accomplished by an electronic mixing system wherein the higher level source is fed into the screen grid of the 6J7 preamplifier tube. Microphone level is controlled by the gain control R_2 , and the phonograph level by R_1 . R_2 , of course, actually affects both signal sources, but this is of no consequence as the phonograph is usually used along with the microphone only for the purpose of providing a music background for speech and this background may be faded in and out by control R_1 without affecting the microphone level. If the phonograph is desired alone, the microphone may be shorted out by the switch S_1 in the control grid of the 6J7.

Built-In Tuner

The simple superheterodyne broadcast tuner used has but one outstanding feature: its tone control. Instead of merely attenuating highs, the control R_3 varies both highs and lows. When R_3 is in full counter-clockwise position, the response of the system is normal; but as the maximum clockwise position is approached, the inverse feedback condenser, C_1 , is in effect brought more and more in shunt with the plate impedance, L_1 . At maximum clockwise position, L_1 and C_1 form a circuit which resonates at about fifty cycles. This has the effect of attenuating highs while at the same time boosting lows considerably in the region below one hundred cycles. The control may be backed off slightly from full clockwise position in order to let highs through without diminishing the bass-boosting effect.

The switch S_2 cuts the tuner in and out of the circuit. The radio volume is varied by the control R_4 , which also functions as the master gain control for the whole system.

Jumping to the output circuit, we find that the output transformer used has a universal

secondary which feeds into a switching arrangement. This arrangement allows the amplifier to be fed, respectively, into a five-hundred-ohm line, into a recording head, or into a speaker voice coil, merely by selecting the correct switch position. When in the recording position, a red bull's eye lights up under the volume indicator meter.

Hum level is kept low, and any tendency toward motorboating is defeated through the use of resistance-capacity decoupling filters and through the use of independent power supplies for the low level channel and for the high level channel. The power supplies are mounted on a chassis separate from that of the amplifier itself. If more input channels than those already provided had been desired, a multi-contact selector switch could have been employed at S_2 , with each contact being brought out to a separate input jack.

Construction

The illustrations show clearly the constructional details of the apparatus. The units are housed in a cabinet of white pine, finished with flat black enamel. The panels are standard 19-inch rack panels with black crackle finish.

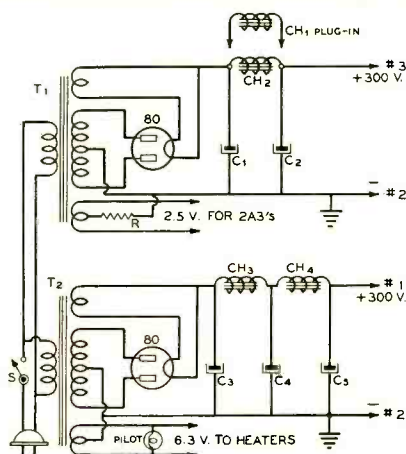

Circuit of the low-level and high-level power supplies.

T_1 —800 v. c.t., 150 ma.; 5v., 2 a.; and 2.5 v. c.t., 5 a.	100-ma. filter choke
T_2 —700 v. c.t., 100 ma.; 5 v., 2 a.; and 6.3 v., 3 a.	C_1, C_2 —16-ufd. 500-volt wet electrolytic
CH_1 —30-hy., 125-ma. filter choke	C_3, C_4, C_5 —8-ufd. 450-volt electrolytic
CH_2 —1250 - ohm speaker field	R —750 ohms, 10 watt
CH_3, CH_4 —30-hy.,	S —S.p.s.t. switch

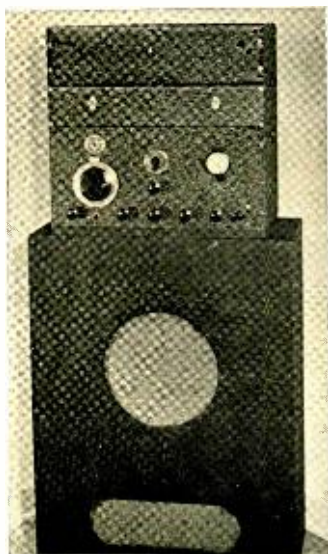

Figure 5. The completed unit and homemade bass-reflex speaker with which the amplifier and tuner are used. The speaker gives excellent quality for reproduction of records and broadcast programs.

Plug-in cables are used between the power supplies and the amplifier so that either unit may be "pulled" for inspection or service independently of the other. Microphone, pick-up, lines, speaker, etc., all plug into sockets mounted on the rear of the amplifier chassis. This, perhaps, does not offer the convenience of a front-of-panel arrangement, but it does keep the controls clear of all cables.

The speaker used for radio and phonograph reproduction is a B-12-X Jensen mounted in a homemade bass-reflex cabinet. This type of speaker and mounting provides wide-range response and works in effectively with the bass-boosting tone control arrangement used in the radio tuner.

Location of Controls

Looking at figure 1, the controls are (from left to right on the panel):

Bottom row:

1. S₁, Microphone switch
2. R₃, Receiver tone control and on and off switch
3. R₂, Microphone fader
4. R₁, Phonograph fader
5. R₅, Low-level tone control
6. S₂, Output selector switch

Middle Row:

1. Large dial, radio tuning control

2. Small knob, S₂, phono-radio switch
3. Small knob with escutcheon, R₄, master gain control.

Looking at figure 2, the jacks and sockets are (from left to right on rear of chassis):

1. 500-ohm line jack
2. Speaker socket
3. 15-ohm line jack for recording head
4. High-level power supply socket
5. Phonograph input jack
6. Low-level power supply socket
7. Microphone input jack

In actual operation the amplifier described in this article has proved to be just about the most useful piece of apparatus which has ever been built at W6DXX. As far as audio frequency equipment is concerned only one additional unit is required: a high-power modulator. Everything else is taken care of by "The Amplifier to End All Amplifiers."

Screen Voltage

ON 6L6's

The plate current of a tube such as a 6L6, T21 or 807 is dependent more upon the screen voltage than upon the plate voltage. Thus, if the screen voltage is low, it will be impossible to get the tube to draw normal plate current even with heavy excitation and loading.

Many amateurs cannot understand why it is impossible to get an 807 to go to 90 ma. out of resonance in an r.f. amplifier when the data sheets call for approximately this amount of plate current for normal operation at resonance. Lowering the bias or raising the plate voltage will have but little effect on the off-resonance plate current. The only way to get the plate current up to where it should be is to raise the screen voltage.

"But the screen voltage is at its rated value now." Are you sure? Did you allow for the drop across the cathode resistor by measuring the screen voltage from screen to *cathode* instead of from screen to ground? With the customary value of cathode resistor there is around 40 volts drop due to the screen and plate current through the resistor when normal values of plate current are drawn. And 40 volts difference in the screen voltage will make quite a difference in the plate current when

[Continued on Page 75]

REMOTE CONTROL SWITCHING

● *without wire lines*

A description of a system whereby various operating frequencies, transmitters, and antennas may be switched at will over a distance of several miles by the use of a small auxiliary transmitter.

By HERBERT J. GLEED, JR.,*

W9BHP

Many of us have often thought that if we could only take our receiver to the ideal receiving location and from there operate the rig at home, we could work those elusive dx stations and at the same time have a very effective break-in system for a snappy local QSO. The greatest drawbacks to such an idea have been the cost and maintenance of wire lines between the home station and the remote control point, and the lack of portability of the remote station. The system described offsets both of these disadvantages, making the first cost the only one.

The first requirement of your home transmitter is that it be relay controlled for changing frequencies, antennas, etc., if it is desired to control it from a distance. Several articles have appeared in RADIO during the past year describing how this may be done.

At the first glance, the circuit of figure 1 may seem complicated, but upon further investigation it will be found that each circuit is very simple. It will be of interest to know that the cost of the control equipment is practically the same if phone, c.w., or both are used. The selector mechanism, the heart of system, will run around \$25, but is money well spent. As G. M. Grening¹ stated, this selector and other telephone equipment can easily be obtained from the several telephone equipment manufacturers.

Relays

Referring to figure 1, the only relays that are specially built and hence should be pur-

chased are relays B and C, which are slow-releasing types and remain closed a second or so after the current is removed. The other relays may be purchased or built from auto-horn relays, or cut-out relays taken from old automobile generators. If the latter are used, the heavy wire must be removed and the winding spaces refilled with no. 26 or no. 28 wire.

The relays D and G must be of the low operating current type designed to work on 5 to 7 milliamperes. Unless one is very dexterous with fine wire and delicate adjustments, the construction of these will be quite a problem and their purchase is thus desirable. The author felt that a reduction in the number of relays in the "lock-up" circuits as used by Grening could be effected with very little loss of flexibility. Hence the circuit control for each piece of equipment was reduced to that of figure 2.

Since the number of contacts on the selector are at a premium, it is advisable to connect the filament control lock-up circuit of the transmitter as shown in figure 3. This allows the use of the same selector "point" for both lighting and turning off the filaments. It will be noticed that no "master-release" relay is included in this circuit; the reason is that whenever "O" is dialed, all the selected circuits are "knocked down," and this would necessitate waiting for the filaments of the transmitter to warm up before a new setup could be dialed.

* 2303 Ohio St., Lawrence, Kans.

¹ October, 1938, RADIO.

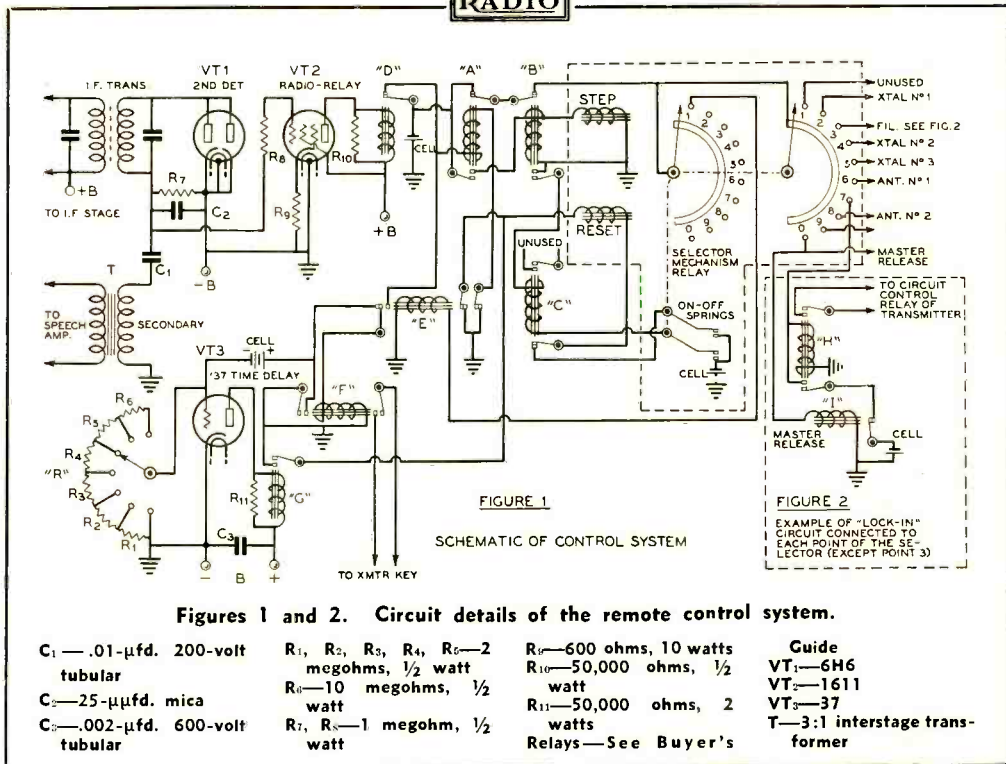

If phone operation is desired, little or no extra equipment is required except that the remote control unit is modulated. The audio to modulate the home transmitter is taken from the 6H6, the second detector as shown in figure 1.

Remote Control Unit

This unit is nothing special and may be that small portable transmitter that is kicking around the shack. It is preferable that it be crystal controlled with an output of 10 to 15 watts, depending of course on the distance between the remote point and controlled apparatus. It will be found that 10 watts is sufficient to control the apparatus over a distance of about five miles.

After much pondering it was decided that the high frequency portion of the ten-meter band or the c.w. portion of the 160-meter band was the best for the control frequency, due to the usual absence of signals. Your choice will depend on the amount of activity in these bands in your locality.

The telegraph key that operates the remote unit may also be used to operate the selector mechanism of the home station by the correct series of signals. If it is desired to use a telephone dial to set up the various circuits, it may be mounted on the panel of the remote

transmitter and connected as shown in figure 4. The cost of this dial is about five dollars and lends a professional touch to the unit. In figure 4 is shown a double-pole switch which can be one of the key type anti-capacity switches. The set of contacts in series with the dial should close before those in parallel with the key.

Since no indicating devices are used at the remote point, some confusion may arise as to which frequency or antenna, etc., is in use at the home station. If such uncertainty does develop it is best to follow telephone practice and dial "O", which will not give you "information" as on your telephone, but will tell you that the home transmitter is clear and ready for orders from the remote point.

How It Works

Let us now see just how the various relays and the selector operate. As an example, let us say it is desired to light the filaments of the home transmitter from the remote location and the filament control circuit is connected to selector "point" number three. The phone dial is whirled for number three and released. This is done, of course, with S₁ of figure 4 in the closed position. It is necessary to open S₁ after each number is dialed, for a second

or two. The operation of the dial has sent three signals to the home station receiver which cause the plate current of the radio-relay tube, VT_1 , to drop to zero, closing relay D three times. This operates relay A thrice, in turn closing relays B and C and advancing the selector to "point" three. Remember that relays B and C are of the slow releasing types, and B closed on the first impulse and remained closed, not following the three separate signals from A; thus no current flowed to the selector points until the contactor came to rest on number three. The slow-release relay is necessary at B to prevent current flowing to points 1 and 2 as the contactor passes over them.

When B releases, two services are performed: (1) The filament-control circuit is closed and "locked in," lighting the tubes of the transmitter. (2) The current is removed from the magnet coil of relay C. After a short pause C opens, closing the circuit of the "reset magnet" of the selector, which returns the contactor of the selector to the off or starting position and we are ready to dial another number and select the desired frequency and antenna, etc. The spring contacts on the selector mechanism close as soon as the selector is moved from the off position. The reset magnet is connected in series with these contacts so that the current is removed from it as soon as the selector reaches the off position.

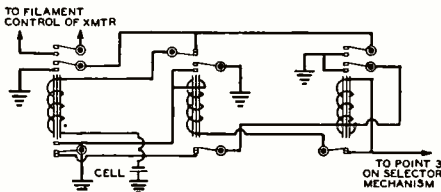

Figure 3. This lock-in circuit is used for filament control only. All other lock-in circuits are connected as shown in figure 2.

The frequency and antenna are selected and we are ready to key the home transmitter from our remote noise-free location. The key circuit, for the sake of simplicity, is connected to "point" one. When we dial number 1, relays A and B close and cause the selector to advance one position. After a short pause B releases and the circuit of relay E "locks in," performing two services: 1. The reset circuit is opened to prevent resetting the selector, which would occur as soon as C released if the contactor were at rest on any other point. 2. A opens, disengaging the selector circuit, which is deadened to any further impulses

from D and the contacts of D are connected to operate F in accordance with signals sent from the remote location. This, in turn, operates the keying relay of the transmitter.

Regarding the circuit of VT_2 and relay G. This tube is a type 37 or one with similar characteristics and is in a time-delay circuit. G is normally open and need not be as sensitive a relay as D. When E is in the off position a small negative voltage is applied to the grid of VT_2 , making the plate current lower than the value required to close G. Closing E removes this voltage and a space charge builds up on the grid, causing the plate current to rise. When this current reaches the operating point of G, the reset circuit is actuated and the selector is reset. This opens E, cutting off the key circuit and restoring A to normal. However, as long as relay F is being operated and the transmitter

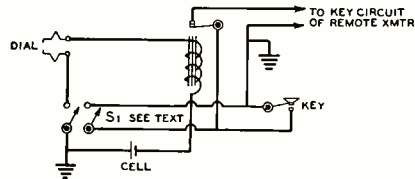

Figure 4. Showing how the dial and key are connected to the control unit.

keyed, no space charge is built up in VT_2 , thus leaving the contacts of G open. If the key is left idle for a predetermined length of time, the selector is reset and all equipment may be "knocked down" by dialing "O". We are then ready to dial a new frequency and antenna. The length of delay in the VT_2 circuit can be adjusted to suit the builder by varying the amount of resistance in the grid circuit.

After the plate-voltage relay closes in the home transmitter, the time to put a signal on the air is about ten seconds, or the length of time required to dial three numbers when leaving a second or so pause between each number. To resume transmission after the stand-by period of a QSO it is not necessary to dial all over again. Simply send a short dash and wait a second for relay B to open. You are then ready to send more information to that choice dx station you are QSOing. The various circuits may seem a little difficult to trace at first glance, but the speed with which the various operations occur is truly fascinating to watch.

[Continued on Page 76]

Reviving

80 and 160-METER DX

About 15 years ago amateurs worked the world on 80 and 160 meters with a few watts input to a UV202 or a pair of 201's. But in those days an antenna was an antenna, and the low frequency waves got off to a good start at a low vertical angle. Presented here are some reasons why fairly low angle radiation is desirable for dx work regardless of frequency.

By E. H. CONKLIN*

During the last five years amateurs have become greatly interested in antenna theory, with some remarkable results. Proper design involves a knowledge of the useful angles of radiation above the horizontal, a subject which now becomes less academic and more practical. Still, there are many rather general or loose comments made about this vertical angle, and only a few cases where actual measurements are available.^{1,2,5}

* Associate Editor, RADIO.

It is often assumed that rather high angles are responsible for communication on eighty meters, possibly presuming that these high angles are simply better for such wavelengths. Little thought is given to the reasons for the assumption, or its accuracy.

The geometry of wave reflection will, in a simple way, illustrate some of the important considerations. For instance, distance, layer height and number of hops alone determine the elevation angle of radiation. Wavelength comes into the problem only as it determines the layer from which reflection takes place and as it affects the vertical radiation pattern of the receiving and transmitting antennas, plus some difference in the amount that the signal is absorbed during transmission.

The Basic Geometry

Figure 1 shows a single hop, with an exaggerated virtual height, b . The earth's radius is shown as r ; the vertical (elevation) angle above the horizon as V . D is the angle at the earth's center which, expressed in minutes, gives one-half of the distance between transmitter and receiver in nautical miles.

It will be seen that the normal hop involves the same vertical angle at transmitter and receiver, as well as at the points of reflection in multihop communication. Furthermore, the triangle TLC is fixed by the layer height and either the length of the hop or the vertical angle. By use of a large scale drawing or by trigonometry, the vertical angle associated with any one-hop distance can be determined for both E and F layers.

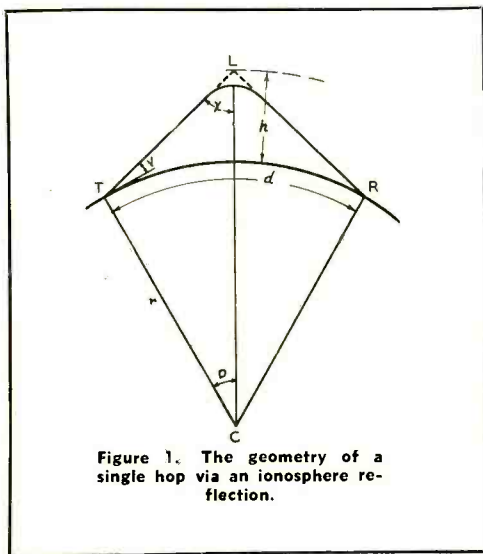

Figure 1. The geometry of a single hop via an ionosphere reflection.

E Layer

Let us assume, first, an E layer reflection. This layer is regularly found between 100 and 130 kilometers above the earth, but except for the summertime sporadic condition, it does not reflect signals on our highest frequency bands. At night, it is usually important only for the broadcast band.

One of the lines in figure 2 shows the results of calculating the vertical angles involved in a single hop of varying distances, assuming a layer height of 100 km. Five-meter reports indicate a maximum one-hop distance of a little more than 1200 miles, suggesting that signals leaving below two degrees are largely canceled if the layer is 100 km. high, or below three degrees if it is at 120 km.

It is immediately apparent that for one-hop communication, only the nearest 29 per cent of the maximum distance is reached by signals leaving or arriving at angles above 20 degrees, an angle below which few amateur antennas above average ground, particularly on the lower frequency bands, produce much power.² More impressive than that, only 8.27 per cent of the area surrounding a station is within this distance, and is reached by one-hop radiation above 20 degrees!

F Layer

As will be seen from figure 2, the case for the F region is a little better. We have assumed a virtual height of 250 kilometers, which appears to be a suitable average figure although this layer has a fairly large seasonal chance.

Signals leaving the antenna above 20 degrees turn back to earth within 730 miles. This represents 37.9 per cent of the 1924-mile maximum distance based on a two-degree minimum vertical angle (the Bureau of Stand-

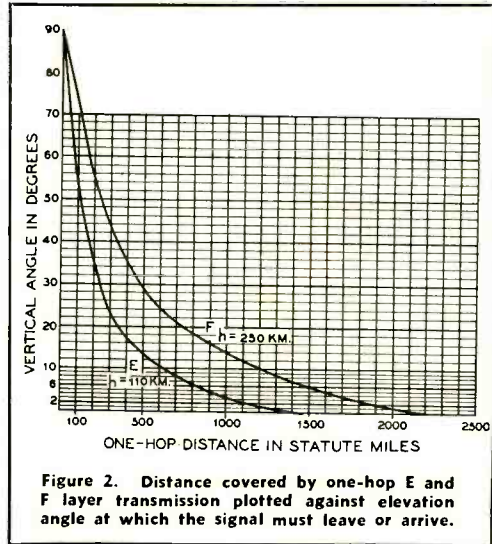

Figure 2. Distance covered by one-hop E and F layer transmission plotted against elevation angle at which the signal must leave or arrive.

ards assumes a 3½-degree minimum angle), but includes only 14.4 per cent of the area that can be reached by a single hop! Chicago-to-New York work by one hop involves an angle of 20 degrees, although via two hops, possible only when Ohio stations are heard at both ends, the angle is 34 degrees.

These figures are somewhat larger than for the E region but in both layers only a small area is reached with medium and high-angle radiation unless there are multiple jumps.

Figure 3 is a scale drawing of a section of the earth and an F layer 250 kilometers high. Radiation leaving the transmitter at O will follow the solid lines, be reflected at the

¹ P. S. Carter, C. W. Hansell, and N. E. Lindblad, "Development of Directive Transmitting Antennas by RCA Communications, Inc.," *Proc. I.R.E.*, October, 1931; H. T. Friis, C. B. Feldman, and W. M. Sharpless, "The Determination of the Direction of Arrival of Short Radio Waves," *Proc. I.R.E.*, January, 1934; R. K. Potter and H. T. Friis, "Some Effects of Topography and Ground on Short-Wave Reception," *Proc. I.R.E.*, April, 1932; H. O. Peterson and D. R. Goddard, "Field Strength Observations of Transatlantic Signals, 40 to 45 Mc.," *Proc. I.R.E.*, October, 1937; "Measuring the Vertical Angle of Signal Arrival," *RADIO*, January, 1938; H. T. Friis and C. B. Feldman, "A Multiple Unit Steerable Antenna for Short-Wave Reception," *Proc. I.R.E.* and *Bell System Technical Journal*, July, 1937.

² E. H. Conklin, "The Effect of Average Ground on Antenna Radiation," *RADIO*, March, 1938.

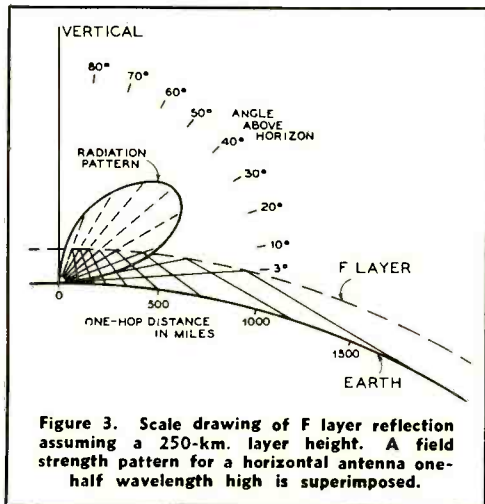

Figure 3. Scale drawing of F layer reflection assuming a 250-km. layer height. A field strength pattern for a horizontal antenna one-half wavelength high is superimposed.

layer, and come down at the distances indicated in figure 2. We have also shown the pattern of relative field strength for a horizontal antenna located one-half wavelength above ground. Field strength varies as the square root of the power, so a power curve would be sharper with relatively less power radiated at the very low and very high angles. It is easy to see that a large range of distances is reached by radiation going out below 20 degrees where the power is falling off rapidly. On our lower frequency bands, horizontal antennas generally are less than a half wavelength high so there is even less power radiated at the lowest angles.

Low-Frequency Bands

Let us pause to repeat that wavelength hasn't entered into the above calculations. Why, then, do we hear all this talk about high-angle radiation on our lower frequency bands? Possibly one factor is the short distance involved in much of the communication at these frequencies, although the way our signals used to get into every corner of the globe on 80 and even 200 meters, at a time when every receiving tube was a triode and few sets used more than two or three of them, proves that dx is a definite possibility. In those days, both for transmitting and for receiving, we generally used the high antennas that were left over from "spark" days. Such antennas, no doubt, were much better for low-angle signals. As receiver gain improved, less attention was paid to receiving antennas which have in many cases degenerated into a few feet of wire with a fairly good response to relatively nearby stations that are reached by high-angle signals, and with poor response for the low-angle, more distant signals. A good low-angle receiving antenna should improve the strength, relatively, of the distant stations (even beyond only 200 miles much more than it will the more local transmitters. This will be more true if the transmitting antennas favor low-angle radiation.

Most amateur 40-meter antennas are not more than one-half wavelength above the ground (roughly 60 feet), while 80- and 160-meter antennas are only small fractions of a wavelength high. The latter, particularly, are worm warmers³ whether they are horizontal or vertical unless a lot of wire has been buried radially under them to shield the strong field from the poor dielectric characteristics of the ground. More height is of great value. Our present low-frequency antennas

put out a lot of power locally, where it is seldom necessary, but the signal doesn't get very far.

Multiple Hops

On our lower frequency bands, E-layer work out toward 1200 miles and F-layer communication approaching 1900 miles may generally take place via more than one hop. If the ionosphere is capable of turning back the higher angle waves, then the number of hops taken by the signal is determined mainly by the relative strength of the several signals arriving at the receiver by different paths. While this is in part determined by absorption during the passage of the waves through the atmosphere and ionosphere, and by reflection losses, it is also determined by the relative power transmitted or received at different vertical angles.

Some idea of the effect of the antenna patterns can be obtained by *multiplying* the patterns of the receiving and transmitting antennas, and plotting the resultant. When these antennas are ineffective at any particular angle, such as at the very low angles, the signal at that angle can hardly predominate at the receiver's input.

Improving the radiation at low angles may make somewhat lower angles effective in communicating between two points, by increasing the power in some path involving fewer hops. Nevertheless the receiving antenna must also be capable of low-angle response to permit loud signals for the path involving the fewest possible number of hops. Suppression of high-angle radiation on our longer wavelength bands, however, mainly reduces the signal at relatively nearby points, which is something of an advantage from the interference standpoint.

Effect on Antenna Design

At the lowest frequencies, there is no wholly effective substitute for increased height of the antenna as a means of improving the vertical radiation pattern. Some improvement on verticals should result from top-loading⁴ in order to raise the current loop (especially when the ground system is not extensive) and to obtain a somewhat lower angle of radiation. Beams are not an impossibility, including the wave antenna (Beverage) where space is available,

[Continued on Page 76]

³N. R. McLaughlin, "Are You a Worm Warmer?" RADIO, July, 1937; E. H. Conklin, "The Worm Turns Cold," RADIO, February, 1938.

⁴C. A. Nickle, R. B. Dome, and W. W. Brown, "Control of Radiating Properties of Antennas," *Proc. I.R.E.*, December, 1934; also discussion in October, 1935, issue.

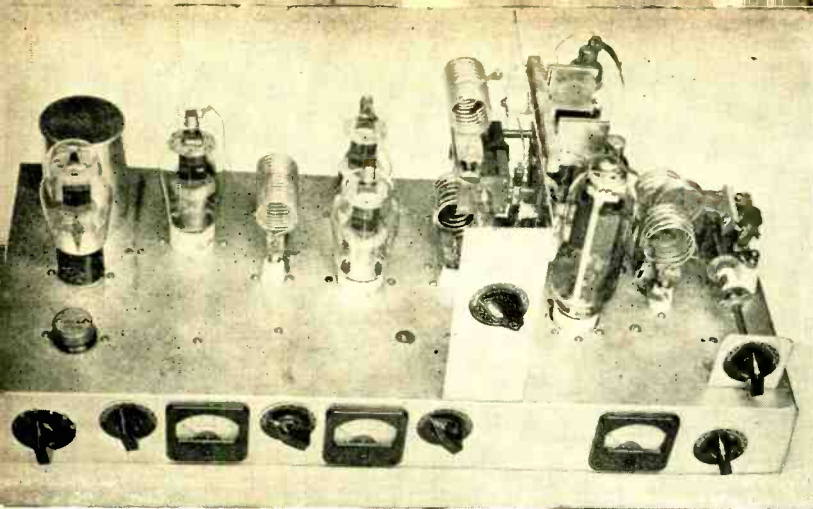

This neat transmitter operates with very good efficiency on 5, 10 and 20 meters. The push-pull amplifier uses a pair of HF-100's.

A 250-WATT TRANSMITTER

Low Cost, Medium Power, High Efficiency

This neat looking transmitter was designed for good efficiency on 56 Mc., and therefore works like a million dollars also on 14 and 28 Mc. Complete construction data are given.

By IRWIN K. WOLFE,* W2KTC

The swift progress of amateur radio during the last few years has seen the frontiers of the ultra high frequency spectrum pushed back further and further until today the once mysterious realms of 28 and 56 Mc. hold few technical problems for the modern amateur. While there is yet much to be conquered in probing antenna operation and the erratic behavior of the ionosphere, the 1939 ultra high frequency transmitter is no longer a collection of unpredictable "haywire."

Those of us who work regularly on 56 Mc. are acutely conscious of the transition of the band from low powered unstable transmitters and broad tuning, hissing, superregenerative receivers to amply powered, stabilized transmitters and selective superheterodyne receivers.

The 250-watt transmitter to be described in this article meets all the standards of operation which 1939 demands of the amateur who

wants to enjoy solid 100% QSO's on both 28 and 56 Mc. In addition it operates with remarkable efficiency on 14 Mc., thus offering all the thrills of the best dx bands.

Designed primarily for use in the three bands already mentioned: 14, 28 and 56 Mc., simplicity of circuit becomes a prime objective in this transmitter, so that we may keep the number of stages to a minimum.

Because of their high output during harmonic operation, beam type tubes were selected for the driver stages. By using beam tetrodes and resorting to harmonic outputs it becomes possible to dispense with both shielding and neutralizing for all but the final amplifier. To simplify further both operation and construction, single-ended amplifier stages employing capacity coupling have been used right up to the final.

The driver-amplifier is link-coupled to the push-pull HF-100's. Throughout the oscillator and all driver stages, regular receiving type condensers are used. Neutralizing condensers

* 153 Schenck Ave., Brooklyn, N. Y.

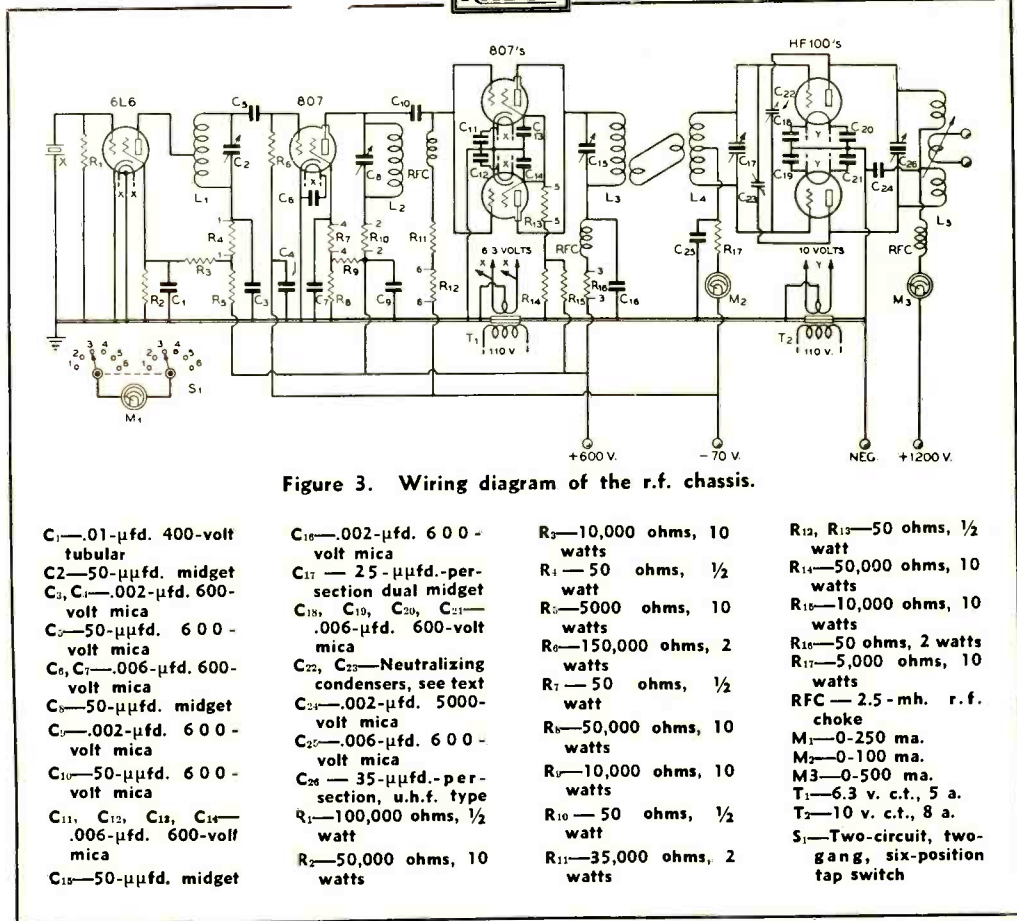

for the final amplifier have been "homemade" from pieces of scrap aluminum, and coils for all bands are likewise homemade.

Tube Line-up

A 6L6G in an ordinary crystal oscillator circuit operates on 7 Mc. for all three bands, since 40-meter crystals oscillate with ease and are relatively inexpensive.

For 14-Mc. operation the first 807 driver stage operates as a fundamental 7-Mc. amplifier. The second driver, a pair of 807's wired in parallel, operates as a doubler on 14 Mc. and thus pushes the high-power final HF-100's as a straight 20-meter amplifier.

28-Mc. operation finds the oscillator still working with the 7-Mc. crystal; the first 807 doubles to 14 Mc. and the parallel 807 stage doubles again to 28 Mc., thus driving the final on 10 meters with equal ease and efficiency.

Operation on 56 Mc. offers no major problems. Again the 7-Mc. oscillator drives the

first 807, which this time quadruples directly to 28 Mc. From here it is an easy job to double in the parallel 807's to 56 Mc. and push the final as a straight five-meter amplifier.

It is important to note that 56-Mc. operation should be the first objective in tuning up this rig. Once achieved, 28- and 14-Mc. operation becomes merely a matter of winding the proper coils. The r.f. circuits, although of conventional design, possess surprising efficiency when correctly adjusted. The often-repeated admonition to keep all leads as short as possible must be heeded in this transmitter, however, and circuit elements have been carefully arranged to achieve this end.

R.f. fields of each stage must be confined and caution taken to reduce stray fields and capacities to a minimum. All by-passes are made direct to a common ground for each stage, usually at the tube socket itself. Only by exercising such meticulous care can satisfactory results be attained on 56 Mc.

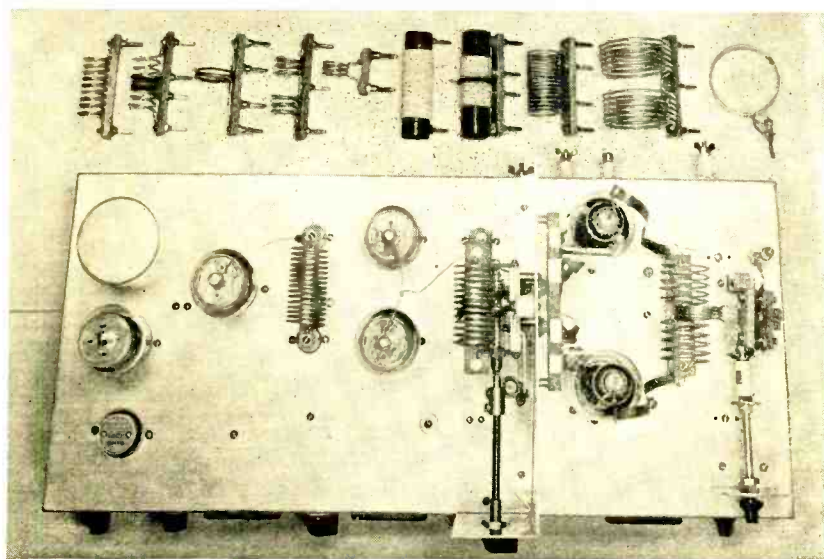

Top view of the transmitter, shown for comparison with plan view of chassis (see next page) to facilitate interpretation of the latter. The various coils shown to the rear are homemade as described in the text.

Chassis Layout and Assembly

A glance at the photographs will show that the transmitter is built on a standard 10" x 23" x 3" electro-plated chassis. Such construction offers instantaneous accessibility to any portion of the unit as well as permitting convenient and easy coil changing. You may fit from one band to another in twenty seconds flat, and if particularly late for your sked, a little extra steam will make it in fifteen.

Tube and coil sockets all have ceramic insulation, as have all variable condenser mountings. Condensers for each tank circuit are mounted directly beneath their associated coils and on the underside of the chassis. Connection is made to the front of the chassis with ceramic couplings and bakelite rods.

All coils for 56 Mc. and 28Mc., as well as the final doubler and antenna coil for 14 Mc., are of self-supporting airwound construction, held in place on $3\frac{1}{2}$ " x $\frac{5}{8}$ " x $\frac{3}{16}$ " micalex strips. Banana plugs at each end of the strip permit regular plug-in use, with receptacle standoffs receiving the coils. Incidentally, when mounting these standoffs it is well to remove the lug usually mounted on top of the insulator, solder a wire to it and replace the lug on the hollow inside of the standoff. The wire in turn is soldered to the tank condenser of that stage.

A shielding plate of stiff aluminum, measuring about 7" x 10" x $2\frac{1}{2}$ ", with the $2\frac{1}{2}$ "

portion bent parallel with the front of the chassis, extends across the chassis itself, serving as a support for the grid condenser, grid coil and neutralizing plates of the final amplifier.

Metering Switch

A further economy is the use of a six-pole, double-deck rotary switch in conjunction with a single 0-250-ma. meter to obtain a complete check on just how each driver stage is operating.

Naturally this facilitates immeasurably the tuning-up process and at the same time allows the operator to observe circuits that need but occasional check-ups. The grid and plate currents of the final amplifier should be, and are continuously metered in this transmitter, as ultra high frequency r.f. can be very whimsical if not carefully tuned to resonance.

The arms of each deck on this switch are connected across the meter, and a 50-ohm resistor is bridged across each pair of adjoining contacts on the upper and lower decks. The circuit to be metered is thus connected in series with one of the 50-ohm resistors. The insertion of this low value of resistance does not affect operation of the metered circuit, while on the other hand, the internal resistance of the meter is so low compared with the 50 ohms across it that the correct reading of the meter remains unaffected also.

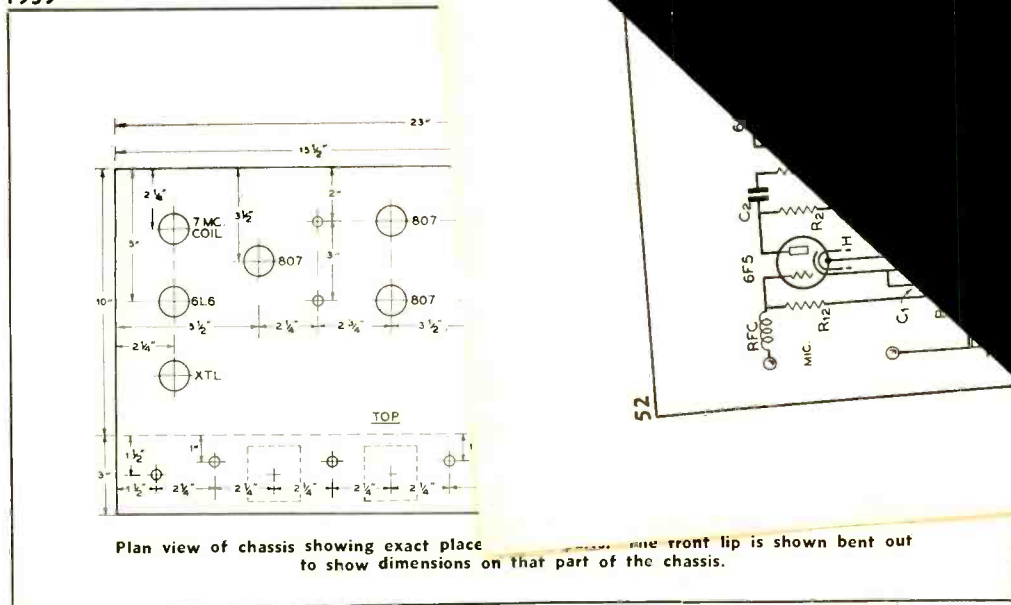

The sequence of contacts on the six-pole switch in this transmitter has been wired up as follows:

1. oscillator plate current
2. first 807 plate current
3. plate current of the parallel 807's
4. screen current of first 807
5. screen current of parallel 807's
6. grid current of the parallel 807's

Neutralizing Condensers

Only in the final stage with the two HF-100's is any form of neutralization necessary, and once adjusted remains permanent for all bands. These neutralizers are cheaply made from scrap aluminum and mounted on a micalex strip which in turn is fastened to the upright shield, already described, with a pair of half-inch collars.

Surface area of these neutralizers is $1\frac{1}{2}$ " x $1\frac{1}{2}$ " for each plate, bent to lap over the micalex strip with an additional tongue of aluminum, which is shaped to grip the strip tightly.

One plate out of each pair of condenser plates is, of course, adjustable and in the bent over tongue is a half-inch slot. The other plate is fastened tightly to the micalex bar.

A small hole in the micalex is carefully tapped for an 8/32 thread so that a locking screw may hold the adjustable plate in place once neutralization has been achieved.

When ready for neutralization, loosen the adjustable plates slightly and move them back to minimum capacity. With the help of a

non-conducting rod, begin tapping each adjustable plate alternately until a minimum reading is obtained in a galvanometer coupled to the final tank. Under ordinary circumstances the spacing of these plates will be found to be about $\frac{1}{8}$ ".

When satisfied that the final stage has been perfectly neutralized, and this is highly important for best efficiency in the ultra-highs, lock the neutralizing screws and forget about them. The neutralizers should never need attention again despite which of the three bands you operate upon.

Coil Construction

With a little care, the home builder can do a workmanlike job on the coils for the transmitter.

Coils for 56 and 28 Mc., as already pointed out, are all airwound and supported against the micalex base strip by the screws which penetrate through it into the banana plugs. The 7-Mc. oscillator coil has been wound on a $1\frac{1}{2}$ " four-prong bakelite form, fitted with a removable shield can. This coil may be purchased all built up if desired, and the form is of the type used for plug-in short-wave receivers. The low frequency of the oscillator does not necessitate ceramic material for this form.

When using the first 807 as a 7-Mc. amplifier for 14 Mc. the plate coil is one wound on a bakelite tube one inch in diameter and $3\frac{1}{2}$ " long, with banana plugs directly in the bakelite. A similar arrangement is employed on the grid coil of the final for 14 Mc., except

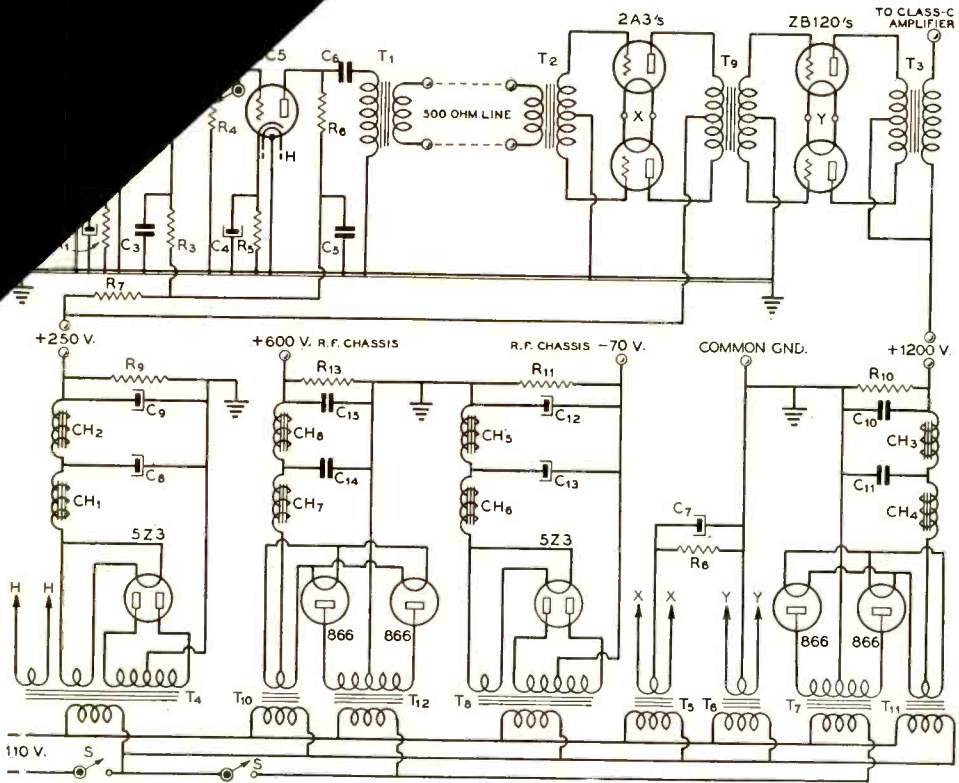

Schematic of the power supplies and modulator.

- C₁, C₁—Dual 10- μ fd. 25-volt electrolytic
- C₂—0.01 μ fd. 400-volt tubular
- C₃—0.25- μ fd. 400-volt tubular
- C₄, C₁—Dual 10- μ fd. 25-volt electrolytic
- C₅, C₆—0.25- μ fd. 400-volt tubular
- C₇—5- μ fd. 100-volt electrolytic
- C₈, C₉—4- and 8- μ fd. dual 450-volt electrolytic
- C₁₀—4- μ fd. 1500-volt oil filled
- C₁₁—2- μ fd. 1500-volt oil filled
- C₁₂, C₁₃—4- and 8- μ fd. dual 450-volt electrolytic

- C₁₄—2- μ fd. 1000-volt oil filled
- C₁₅—4- μ fd. 1000-volt oil filled
- R₁—2000 ohms, 1 watt
- R₂—250,000 ohms, 1/2 watt
- R₃—100,000 ohms, 1/2 watt
- R₄—250,000-ohm potentiometer
- R₅—1500 ohms, 1 watt
- R₆—100,000 ohms, 1 watt
- R₇—25,000 ohms, 2 watts
- R₈—500 ohms, 10 watts
- R₉—30,000 ohms, 20 watts

- R₁₀—50,000 ohms, 50 watts
- R₁₁—800 ohms, 25 watts
- R₁₂—2 megohms, 1/2 watt
- R₁₃—50,000 ohms, 50 watts
- T₁—Triode plate-to-500-ohm line
- T₂—500-ohm line-to-push-pull grids
- T₃—300-watt variable ratio class-B output trans.
- T₄—700 v. c.t., 145 ma.; 5 v., 3 a.; 6.3 v., 4.5 a.
- T₅—2.5 v. c.t., 5.25 a.
- T₆—10 v. c.t., 8 a.
- T₇—3750 v. c.t., 500 ma.

- T₈—250 v. c.t., 200 ma.; 5 v., 3 a.
- T₉—15-watt variable ratio driver transformer
- T₁₀—2.5 v. c.t., 10 a.; 2000-v. insulation
- T₁₁—2.5 v. c.t., 10 a.; 7500-v. insulation
- T₁₂—1500 v. c.t., 300 ma.
- CH₁, CH₂—12 hy. 150 ma.
- CH₃—12 hy. 500 ma.
- CH₄, CH₅—8 hy. 150 ma.
- CH₆, CH₇—Swinging choke, 5-20 hy. 300 ma.
- CH₈—12 hy. 300 ma.

that the tubing in turn is mounted on a mica-lex strip held off by quarter-inch brass collars, thus permitting the installation of two additional banana jacks for the link. This two-turn link is wound around the center of the coil with 18 ga. wire. Cotton covered wire coils are painted with clear Duco cement, which holds the wire rigidly in place.

In building the grid coils for the final, bare a portion at the exact top center and solder thereon a lug. Then bring the grid center tap up alongside the shield across the chassis to a small standoff insulator, from which a flexible wire and clip make connection to any grid coil easy.

The table of coil turns and wire sizes which accompanies this article lists the necessary data for building coils which under actual operation in this transmitter have given optimum results. A few additional words of explanation are desirable since these inductances play such an important part in the efficiency of the transmitter.

Tank coils for the final amplifier are all of the split type (airwound), to permit accurate variable coupling to the antenna. The best way to build these is to place four studs or screws on a winding form one at each end and the other two on each side of exact center, separated by about a half inch. Wind one section of the coil from the end of the form to the first center stud, jump the wire across the intervening space to the other and then continue winding the coil. Be careful, however, that each section of the finished coil has equal spacing and turns. The antenna coupling coil is mounted with more banana plugs into a mica-lex bar which in turn is pivoted on a bakelite rod that extends to the front of the chassis. By turning this rod it is possible to drop the coupling coil down into the gap of the split coil and attain any desired degree of antenna loading. Flexible leads travel to standoffs at the edge of the chassis from the coupling unit so that the feed line may be easily attached.

Power Supplies

A five-prong receptacle is provided for supplying filament, plate and bias voltages for the oscillator and driver stages. Any power

unit delivering between 600 and 700 volts at 300 ma. will fill the need admirably, but a separate bias supply of 70 volts is required for the drivers. A pair of terminals are provided for the ten-volt, five-ampere, filament supply for the HF-100's. In addition, a ground terminal directly to the chassis and a feed-through insulator for the 1000 to 5000 volt final power supply are included. The HF-100's are self-biased through a cathode resistor.

The individual constructor may follow any plan he finds advisable for power supplies, but at W2KTC three 13" x 17" x 3" heavy duty chassis were used, one carrying the high and low voltage transformers, along with a pair of 866 rectifiers for each supply. The second chassis contains the filter equipment for both packs, with a 5/20-hy. swinging choke, a 2- μ fd. filter, a 20-hy. filter choke, and then 4 μ fd. more of filter.

In addition the complete bias pack is mounted on another smaller chassis. The third large chassis houses the speech equipment.

Modulators and Speech

The audio section is purely conventional and will be sketched only in brief fashion. An ordinary preamplifier is coupled via a 500-ohm line to the grids of a pair of 2A3's in class-A push-pull and these drive a pair of ZB-120's, as zero-bias class-B modulators.

Tuning Up the Transmitter

Preparing the completed rig to take to the air is a simple matter, although the suggestion is again repeated that the first frequency undertaken should be 56 Mc. Keep the high voltage from the final HF-100's and if possible, reduce the voltage on the 807 drivers while tuning up.

One of the major problems in tuning up any crystal-controlled transmitter for the ultra high frequencies is the danger of getting stages resonant on intermediate harmonics rather than the desired ones.

Adjustments can be greatly facilitated by the use of a small tuned circuit (absorption wavemeter) for 56 and 28 Mc. It is constructed using a 25- μ fd. midget condenser and the 56- and 28-Mc. coils made interchangeable.

[Continued on Page 77]

Approximate Meter Readings						
	6L6 PI	807 PI	2-807 PI	1-807 S.G.	2-807 S.G.	2-807 G.
56 Mc.	55 ma.	55 ma.	165 ma.	6 ma.	8 ma.	5 ma.
28 Mc.	55 ma.	18 ma.	80 ma.	12 ma.	25 ma.	8 ma.
14 Mc.	55 ma.	12 ma.	55 ma.	14 ma.	28 ma.	12 ma.

Plate voltage of 600 volts to drivers and 1200 volts to HF-100's, with grid current of 42 ma., and plate current of 300 ma. on latter during above meter tests.



TAKING TEN

For A Ride

With the u.h.f. converter described last month, an auto radio, and this 10-watt 10-meter mobile transmitter you have a complete mobile station, one capable of working thousands of miles under favorable conditions. Working dx stations while driving along at 50 m.p.h. is amateur radio's newest thrill.

By F. R. CONSETT, * W6VR

Ten-meter mobile activity has grown to a point where mobile work represents a considerable portion of the work on this band. Ten meters allows some very fine dx contacts besides acting much the same as 56 Mc. locally.

In the previous issue of RADIO there is shown a very simple converter for use with a regular b.c. auto radio. Combined with this transmitter, a splendid mobile station is the result.

When operating a transmitter of this type it is better to secure a frequency as free from QRM as possible, because of the relatively low power used. However, the transmitter described will make its share of QRM and put a dent in many of the one-kw. boys. The high frequency portion of the ten-meter band is perhaps the best bet.

Electrical Design

The crystal oscillator uses a 6F8G in a conventional twin triode oscillator-doubler circuit. Note that in this tube each cathode is brought out to the tube base. When using a 6A6 in this type of circuit the cathode is common and will not allow separate cathode bias and metering for the respective sections.

The first tuned circuit is tuned to the fundamental frequency of the crystal, which in this case is on 7 Mc. For police use a crystal somewhere in the neighborhood of 9 Mc. will be used. The cathode of the oscillator circuit

is grounded and all bias comes from the grid leak. Thus the plate current will dip upon hitting resonance. The current drawn by this circuit will be about 15 ma.

The second section of the tube is used as a triode doubler with the plate circuit tuned to the 20-meter band. The two sections are coupled through a .00005- μ fd. condenser, which affords the proper amount of excitation. Bias for this section is supplied by a 150-ohm resistor placed in the cathode and a 50,000-ohm grid leak.

The T21 final amplifier operates as a doubler. Fewer parts are required, and any inexpensive pentode or tetrode may be used, as neutralization is not made necessary by lack of perfect screening within the tube. Since in most cases the voltage used on mobile equipment is in the neighborhood of 300 volts, tubes such as the 41, 42, T21, etc., make splendid finals at low cost.

In the unit described the T21 cathode current dips to 15 ma. with no load. For ten-meter operation this is considered very good even for a "straight through" final amplifier. Out of resonance the cathode current is around 60 or 70 ma. The current measured is cathode current, which includes control grid, screen, and plate current. When the stage is connected to an antenna the cathode current should read around 60 to 70 ma. At this loading the output will be around 10 watts.

Plate modulation of the T21 is provided by a pair of 6V6's in push-pull. They will operate very well right out of a carbon microphone if a high ratio microphone trans-

* Technical Assistant, RADIO.

Under-chassis view of the 10-watt 10-meter mobile transmitter. The midge t tuning condensers are of the type permitting mounting on a metal chassis by support studs connected to the insulation rather than to the condenser rotors. They are tuned by means of a screw-driver.

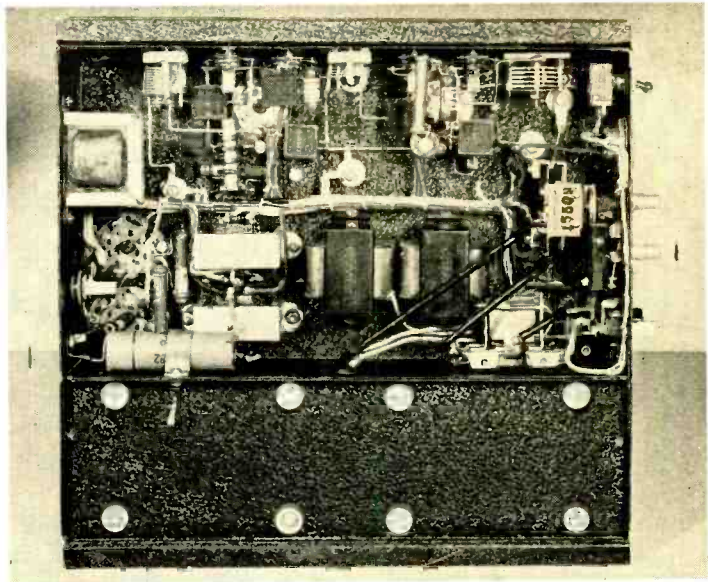

former is used. Thus no speech amplification is required ahead of the modulators, thus eliminating extra tubes, battery drain, etc. The input transformer used has a 50-ohm primary and a 200,000-ohm center-tapped secondary.

The resting plate current on the modulators is about 50 ma. This makes a total of around 85 to 90 ma. being drawn by the exciter and modulators, which are supplied voltage from one vibrator pack.

Relays

The relays used are of the six-volt type, drawing about 700 ma. each. One is a single-pole single-throw; the other is a double-pole double-throw. The first relay is used just to turn on the filaments to the transmitter. At this point we cannot stress too strongly the necessity of having the highest battery voltage possible at the transmitter. It is for this reason that the relay was used in the A lead. Sometimes transmitters have been installed with a switch elsewhere in the A voltage lead and by the time the battery voltage arrived at the rig, you would need tubes with 5-volt filaments.

Another advantage of having the relay in this part of the circuit is that only one wire is required from the front part of the car to turn on the filament voltage. All relays are operated by means of switches to ground; thus the relays are connected to the "hot" A voltage at all times.

The second relay switches the A voltage to the vibrators, keeping the voltage drop here at a minimum, too. The other part of the

relay throws the antenna back and forth between the receiver and transmitter, permitting use of one antenna for both the receiver and transmitter.

Power Supplies and Battery Drain

The transmitter unit is designed to operate with a full 300 volts, and in order to obtain the proper voltage and have sufficient current carrying capacity, it is necessary to use two vibrator supplies. The vibrators have individual filter networks, as may be seen in the diagram. A single 300-volt 150-ma. dynamotor could be substituted for the two vibrator supplies if desired.

The total drain on the car battery with the transmitter in operation is about 18-20 amperes. The author has a small trickle charger permanently mounted right in the car and when he stops he plugs it into the nearest convenient a.c. outlet. Many of the newer cars come equipped with heavy duty generators capable of handling easily the load offered by the transmitter, and auxiliary charging of the battery will seldom be required.

While on the subject of batteries, one thing that may be of help will be mentioned in regard to the converter described in the January issue. After a transmission there was quite a delay before the receiver would suddenly pop back into operation. This caused quite a few grey hairs to sprout before it was discovered that the battery voltage had dropped due to the heavy drain placed upon it from the transmitter. This low battery voltage

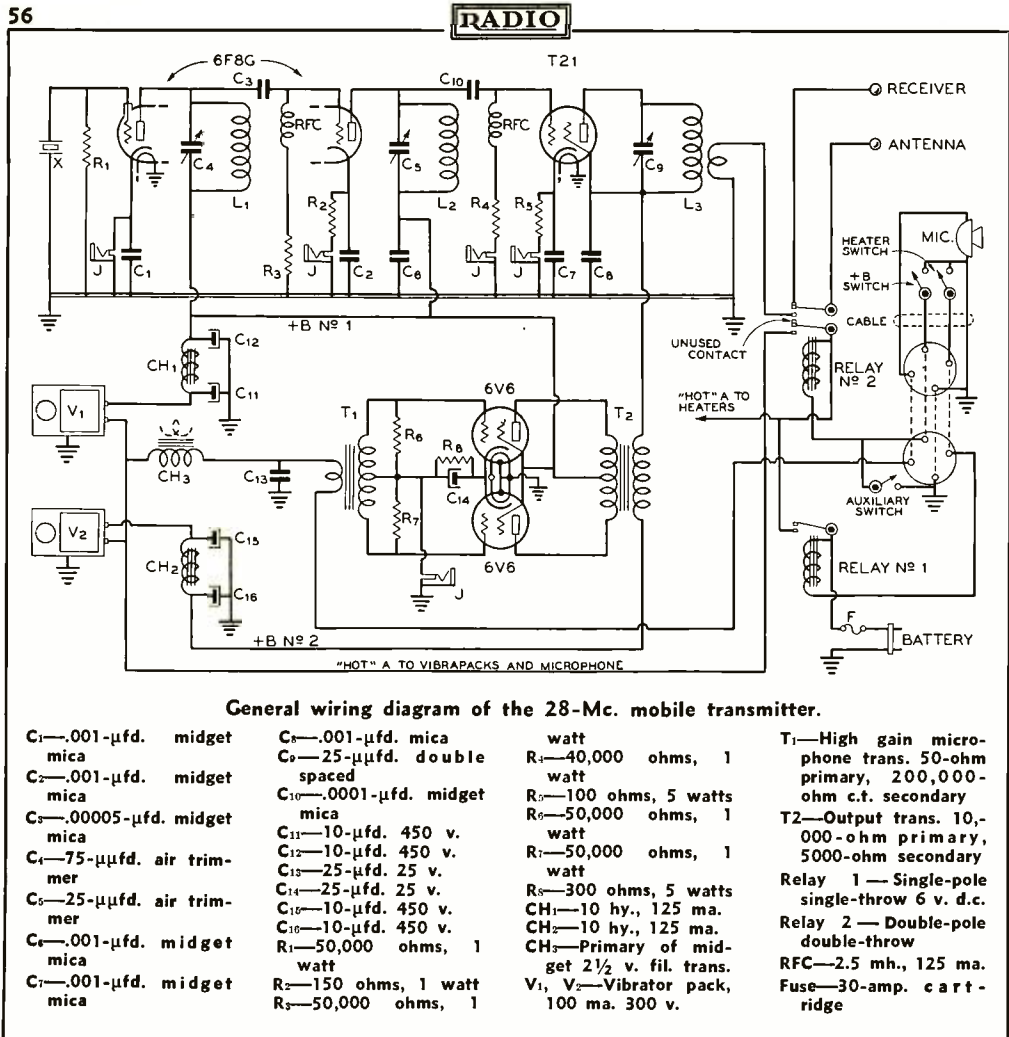

caused the receiver to be inoperative because the oscillator would not oscillate with a low potential on the 6J8 heater. With proper charging and a lively battery no trouble is experienced.

The microphone voltage is obtained from the main battery through a small decoupling choke, which is the primary of a small 2½-volt filament transformer. The choke, in conjunction with the 25- μ fd. condenser C₁₅, removes every last trace of vibrator hash.

The Antenna

Several antenna systems were tried, but after careful tests a simple quarter wave against the car body was chosen. The antenna is mounted on the rear bumper and is fed with a concentric line, which may be either ordinary shielded wire or the "bead line" type which

may be obtained from any large supply house. The direction of the car affects the signal strength somewhat. The signal strength is highest with the car pointed towards the station being worked.

Operation

When the transmitter was first installed in the car a push-to-talk arrangement was used, but a few days with this arrangement proved that it was out of the question to work the transmitter and remain a safe and sane driver. After words with several traffic officers and what with missing a telephone pole by inches, it was realized that a new system of operation had to be devised. A telephone operator's chest set was obtained and the switches were

[Continued on Page 78]

FLASHER-TYPE

Modulation Indicator

By ORBRA HARRELL,* W4BIN

The modulation percentage indicator to be described in this article gives a warning flash whenever a predetermined modulation level has been reached or exceeded. The percentage setting is continuously variable from very low percentages to over 100 per cent. It also is capable of indicating either on positive or negative peaks at the will of the operator. The settings of the control potentiometer, once marked and calibrated, will give accurate indication of the modulation percentage at any time. A phone jack is incorporated in the return circuit of the detector tube so that the quality of modulation may be checked aurally when desired.

The indicator is very simple considering its versatility; only two small tubes are used, a 56 and an 885 gas triode. The power supply is extremely simple and is self-contained. In addition, a 0.5 d.c. milliammeter is required to adjust the operating current on the detector to the proper value. This meter also serves as a carrier shift indicator. The total power supply for the indicator is taken from one of the small tube-tester filament transformers with taps from 1½ to 30 volts. The completed unit requires only a very small amount of r.f. for drive; a small loop near the final tank of the transmitter will usually be sufficient.

Circuit Details

The circuit consists of an ordinary diode detector with a milliammeter in the diode return circuit. A switching arrangement is incorporated which changes the variable resistance load from the cathode to the plate return circuit; this allows the measurement of both positive and negative peaks of modulation. The audio which is developed across the load resistor, which is changed 180° in phase when the load resistor is changed from cathode to plate, is fed to the grid of the 885 trigger tube. This tube is ordinarily biased to cutoff with no signal input but when the audio peaks reach such a value that the tube is triggered, plate current will flow and the dial lamp will light.

Due to the trigger characteristics of the 885, as soon as plate current has started to flow it continues to flow at the full value determined by the amount of resistance in series with it and the plate voltage being applied for the remainder of that half cycle of alternating current being supplied to it by the transformer, T. In other words it is drawing practically full plate current or no plate current at all. This "go-no go" characteristic is common to all gas triodes and grid-controlled rectifiers.

Since a.c. is used on the plate of the 885, a.c. may also be used on the control grid if the polarity of the grid voltage is adjusted so that it is 180° out of phase with the plate voltage. This is accomplished by tapping the grid on one extreme end of the transformer, the cathode 5 volts higher up than the grid (more than sufficient for cutoff with 30 volts r.m.s. on the plate), and the plate on the other extreme end. Thus, at *peak* a.c. conditions the plate will be approximately 35 volts above the cathode ($\sqrt{2}$ times 25 r.m.s. volts) and the grid will be about 7 volts *peak* below cathode. The tube will thus be biased to cutoff. The polarities of these voltages will reverse on the other half cycle but since the plate is negative on this excursion no plate current will flow.

The operating characteristics of the 885 are such that once the gas has been broken down and has begun to pass plate current, the current will continue to flow until the plate voltage has been removed. Therefore, whenever the tube has been triggered by a peak of modulation, the plate current will continue to flow for the balance of the half cycle of the 60-cycle voltage being delivered to it by its power transformer. This feature of the tube works to an advantage in this case because the lengthening out of the instantaneous pulses of overmodulation allows the filament of the flasher to reach full temperature before the current stops. And yet, after the passing of this 120th second pulse, the current has stopped in readiness for the next pulse of overmodulation.

Operation of the Indicator

The operation of the indicator, after its installation, is quite simple. With the monitor

* 361 Nelms Ave., N. E., Atlanta, Ga.

connected to the transmitter and the transmitter on the air, R_1 is adjusted so that the milliammeter reads 4 ma. For proper operation, this resistor or the coupling to the transmitter must always be adjusted so that the milliammeter reads 4 ma. Now, with this condition existing, the dial lamp will flash when a predetermined percentage of modulation has been reached; the point at which the flash will take place is determined by the setting of the calibrated control, R_2 .

An audio check may be had at any time by plugging a pair of phones into the jack, J. However, the flasher will not operate with the phones in the jack because the series resistance network is shorted out when the phones are inserted.

Calibration of the Indicator

Now for the calibration of the indicator and of the settings of R_2 , and the determination of the permanent setting of R_3 , the following procedure is followed. In order accurately to make these adjustments and calibrations it will be necessary to borrow or otherwise to obtain an oscilloscope or other modulation percentage indicating device, an output meter calibrated in decibels, and a source of constant tone of some frequency between 250 and 1000 cycles. First connect the output meter to the output of your receiver with constant tone input and modulate your transmitter 100% (negative peaks) as indicated by the oscilloscope. Adjust the volume on the receiver so that the output meter reads zero db. With the modulation meter connected and operating, set R_2 to about two-thirds of the way toward the ground end. Now adjust R_3 so that, with the transmitter being modulated 100% by the oscilloscope, the flasher just begins to turn on. (It will become fully brilliant as soon as this point is reached.) This adjustment must be made carefully as the setting of this potentiometer is to be permanent.

Now mark the point to which the pointer of R_2 is directed as 100%. It must be remembered that all these adjustments must be made with S thrown so that the resistor network is in the plate return position—the position to read negative peaks. The oscilloscope is no longer needed—as a matter of fact, any type of accurate negative peak modulator or indicator to show when 100% negative has been reached may be used instead of the oscilloscope.

Now reduce the gain on the speech amplifier of the transmitter until the output meter indicates minus 1 decibel. This corresponds to 89% modulation of the transmitter. Then vary R_2 so that the flasher just starts again. Mark this position of the pointer as 89%.

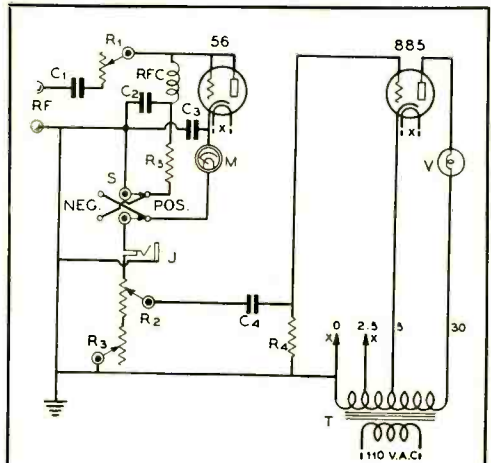

Schematic of flasher-type modulation indicator.

- | | |
|---------------------------------------|--|
| C_1, C_2, C_3 —0.001- μ f. mica | equal to d.c. res. of M) |
| C_4 —0.1- μ f. 400-volt tubular | RFC—2 $\frac{1}{2}$ -mh. r.f. choke |
| R_1 —10,000-ohm rheostat | S—D.p.d.t. toggle switch |
| R_2 —1500-ohm potentiometer | M—0-5 d.c. milliammeter |
| R_3 —1000-ohm potentiometer | J—Phone jack |
| R_4 —10,000 ohms, 1 watt | T—Tube tester transformer tapped 0 to 30 volts |
| R_5 —50 ohms (or | V—6-volt pilot lamp bulb |

This procedure is repeated in steps down to about 20% modulation and the pointer is calibrated each time.

The following db steps give equivalent percentages of modulation:

Decibels	Per cent modulation
0	100
—1	89
—2	80
—3	71
—4	63
—5	56
—6	51
—8	39
—10	32
—12	25
—15	18

With R_2 now calibrated the indicator will flash when a given percentage of modulation is reached as indicated by R_2 . Also, this calibration will hold true on both positive and negative peaks of modulation as obtained by changing the switch S.

[Continued on Page 78]

● Winter at the Central Monitoring Station, Grand Island, Nebraska. (Photo courtesy Inspector Benjamin Wolf)



DEPARTMENTS

- **Dx**
- **Yarn of the Month**
- **Postscripts and Announcements**
- **New Books**
- **56 Megacycles**
- **112 Megacycles**
- **Open Forum**
- **Scratchi**

RADIO

"WAZ" HONOR ROLL

C.W. AND PHONE

Zones Coun-tries

ON4AU .. 40 .. 148	G5BD .. 37 .. 110	W6MCG .. 35	SM6VX ... 31 .. 76
G2ZQ .. 40 .. 143	W8EUY .. 37 .. 105	W6NHC .. 35	W2GFF .. 31 .. 75
W3EVT .. 40 .. 126	W9PTC .. 37 .. 103	SU1WM .. 34 .. 109	W2BZB .. 31 .. 75
W8CRA .. 39 .. 151	G2QT .. 37 .. 103	W6HEW .. 34 .. 103	W9YEG .. 31 .. 75
G6WY .. 39 .. 151	VE2EE .. 37 .. 102	W8BSF .. 34 .. 100	W6NNR .. 31 .. 74
W6CXW .. 39 .. 150	G6GH .. 37 .. 102	VK2AS .. 34 .. 94	G5VU .. 31 .. 73
W6GRL .. 39 .. 141	W2IYO .. 37 .. 102	W6EPZ .. 34 .. 93	W6OEG .. 31 .. 72
W8BT1 .. 39 .. 141	W6FKZ .. 37 .. 101	W8HGA .. 34 .. 93	W5PJ .. 31 .. 71
W6ADP .. 39 .. 140	W6JBO .. 37 .. 101	W6HJT .. 34 .. 92	W9VKF .. 31 .. 68
W6BAX .. 39 .. 140	W6ITH .. 37 .. 100	W9GBJ .. 34 .. 90	W6POZ .. 31 .. 66
W6CUH .. 39 .. 140	W8KPB .. 37 .. 100	W8OUK .. 34 .. 84	VK2VA .. 31 .. 62
W4CBY .. 39 .. 138	W9AJA .. 37 .. 99	W6CVW .. 34 .. 84	W6OFC .. 31 .. 62
W8OSL .. 39 .. 133	W3AYS .. 37 .. 98	W8JSU .. 34 .. 83	W9VWV .. 31 .. 60
W2GWE .. 39 .. 129	W3EXB .. 37 .. 98	W9BCV .. 34 .. 83	W6IES .. 31 .. 57
W6KRI .. 39 .. 129	W6ITH .. 37 .. 98	ZS1CN .. 34 .. 82	W9NRB .. 31 .. 54
W7BB .. 39 .. 123	W1BGC .. 37 .. 97	VK2TF .. 34 .. 81	W6CLA .. 31 .. 51
W6HX .. 39 .. 123	ZL2CI .. 37 .. 97	W6MJR .. 34 .. 81	I1TKM .. 31 .. 51
G5BJ .. 39 .. 120	W3AYS .. 37 .. 97	ON4SS .. 34 .. 80	VK2QL .. 31 .. 51
W2CYS .. 39 .. 117	W6VB .. 37 .. 97	VK2TI .. 34 .. 75	W3DCG .. 31 .. 51
W3EJV .. 39 .. 117	ON4T .. 37 .. 96	W7AVL .. 34 .. 75	W6HXU .. 31 .. 51
G2LB .. 39 .. 115	W9CWW .. 37 .. 96	W4ELQ .. 34 .. 74	W6NLZ .. 31 .. 51
W6FZL .. 39 .. 112	W7BYW .. 37 .. 93	W8JK .. 34 .. 74	W9YGC .. 31 .. 51
ON4FE .. 39 .. 110	W5CUJ .. 37 .. 93	W6ONQ .. 34 .. 72	VE2GA .. 30 .. 84
W6FZY .. 39 .. 109	W1GDY .. 37 .. 92	W6LHN .. 34 .. 71	W4DCZ .. 30 .. 80
W3EJV .. 39 .. 104	J2KG .. 37 .. 92	VK2EG .. 34 .. 70	W3CDG .. 30 .. 78
XE1BT .. 39 .. 90	VK2AE .. 37 .. 90	VE5MZ .. 34 .. 69	W3UVA .. 30 .. 76
K6AKP .. 39 .. 87	W6GCB .. 37 .. 81	VK2VN .. 34 .. 63	W3GHB .. 30 .. 73
G6VP .. 39 .. 87	W9UBB .. 37 .. 77	W9QOE .. 34 .. 56	W3GMS .. 30 .. 72
W3ANH .. 39 .. 87	G6NJ .. 37 .. 77	K6JPD .. 34 .. 56	W2GFF .. 30 .. 71
W4DHz .. 39 .. 87	W2BSR .. 37 .. 77	W2FAR .. 34 .. 56	W8MFB .. 30 .. 71
W2BHW .. 38 .. 149	W2DTB .. 37 .. 77	W3EGO .. 34 .. 56	W4DTR .. 30 .. 68
W1BUX .. 38 .. 145	W4AH .. 37 .. 77	W8CNZ .. 34 .. 56	W8MPD .. 30 .. 66
W2GT .. 38 .. 143	W2BJ .. 36 .. 116	W8ACY .. 33 .. 94	W9VLQ .. 30 .. 68
W2GTZ .. 38 .. 141	VK3EO .. 36 .. 112	W5ASG .. 33 .. 94	W8PHD .. 30 .. 57
W8BKP .. 38 .. 138	W1AQT .. 36 .. 108	W6GK .. 33 .. 94	W6PNO .. 30 .. 53
W6KIP .. 38 .. 137	W9AFN .. 36 .. 105	W1APA .. 33 .. 91	W8DPY .. 30 .. 53
W2GW .. 38 .. 137	W1RY .. 36 .. 104	W2BMX .. 33 .. 90	VE5ZM .. 30 .. 52
W5VW .. 38 .. 132	W6BAM .. 36 .. 103	W6KUT .. 33 .. 90	W7ENW .. 30 .. 51
W6DOB .. 38 .. 131	G2QT .. 36 .. 103	W6CEM .. 33 .. 88	W3EMA .. 30 .. 51
W2HHF .. 38 .. 130	W3GHD .. 36 .. 102	W3RT .. 33 .. 86	W8DED .. 30 .. 51
W1ZB .. 38 .. 129	ON4EY .. 36 .. 101	W1APU .. 33 .. 85	W8MAH .. 30 .. 51
W2HHF .. 38 .. 127	W1AQT .. 36 .. 100	W6LEE .. 33 .. 85	W91WE .. 30 .. 51
W5BB .. 38 .. 127	J2JJ .. 36 .. 100	W8QDU .. 33 .. 85	PHONE
W3EMM .. 38 .. 124	W8LZK .. 36 .. 99	W9LQ .. 33 .. 84	W2AZ .. 37 .. 100
W6QD .. 38 .. 124	W4DMB .. 36 .. 98	W2WC .. 33 .. 83	F8UE .. 33 .. 95
W4CYU .. 38 .. 123	W4IO .. 36 .. 98	W6NAE .. 33 .. 83	KA1ME .. 35 .. 79
W3EDP .. 38 .. 121	G2QT .. 36 .. 98	VE4LX .. 33 .. 82	W2IYO .. 34 .. 88
W8LEC .. 38 .. 121	VE1DR .. 36 .. 98	W6LCF .. 33 .. 78	W6ITH .. 34 .. 87
W3EPV .. 38 .. 121	ON4VU .. 36 .. 96	W5PJ .. 33 .. 78	W6OCH .. 34 .. 87
W8DFH .. 38 .. 119	ZL1HY .. 36 .. 95	W6MVQ .. 33 .. 77	W3FJV .. 34 .. 71
W9PST .. 38 .. 119	G2IO .. 36 .. 94	W9TJ1 .. 33 .. 76	W9NLP .. 33 .. 74
W2AAL .. 38 .. 118	G6YR .. 36 .. 94	W7AVL .. 33 .. 71	W3FAM .. 33 .. 68
W8DWV .. 38 .. 118	W7AYO .. 36 .. 94	W2FAW .. 33 .. 67	W6NNR .. 32 .. 73
W1CC .. 38 .. 116	W6KWA .. 36 .. 92	OK2HX .. 33 .. 66	W6CQ1 .. 32 .. 70
W3DDM .. 38 .. 116	W9KA .. 36 .. 92	VK2RA .. 33 .. 65	VE1DR .. 32 .. 59
W9UQT .. 38 .. 116	W9PK .. 36 .. 92	W6KQK .. 33 .. 63	W4CYU .. 31 .. 88
W3GAU .. 38 .. 115	W5ENE .. 36 .. 91	K6CGK .. 33 .. 62	W6MLQ .. 31 .. 72
W5KC .. 38 .. 115	W9CWW .. 36 .. 91	ON4TA .. 33 .. 62	W6LLG .. 31 .. 68
W6AM .. 38 .. 115	W4ADA .. 36 .. 90	W5AXF .. 33 .. 62	W2GW .. 31 .. 65
W8HWE .. 38 .. 112	W8JAH .. 36 .. 89	W6LDJ .. 33 .. 62	W9TIZ .. 31 .. 62
W8AU .. 38 .. 112	W8MTY .. 36 .. 86	W8LDR .. 33 .. 62	F8KI .. 31 .. 53
W2BXA .. 38 .. 111	VK2NS .. 36 .. 84	W9LBB .. 33 .. 62	W6AM .. 31 .. 53
W6GRX .. 38 .. 111	G2UX .. 36 .. 83	VK2VQ .. 32 .. 99	W4AH .. 31 .. 51
LY1J .. 38 .. 110	W6TI .. 36 .. 80	W6DIO .. 32 .. 90	W2AOG .. 30 .. 77
W6H2T .. 38 .. 110	W6GXC .. 36 .. 76	W3KT .. 32 .. 85	W9Q1 .. 30 .. 75
W8KWI .. 38 .. 108	W7DSZ .. 36 .. 73	G6WB .. 32 .. 84	VE1CR .. 30 .. 68
W8OQF .. 38 .. 108	W2GXH .. 36 .. 71	W1APU .. 32 .. 83	W6O1 .. 30 .. 66
W2BMX .. 38 .. 107	G6GL .. 36 .. 71	W9FLH .. 32 .. 80	W7BVO .. 30 .. 64
W8BXX .. 38 .. 106	U1AD .. 36 .. 71	ON4NC .. 32 .. 79	W4DSY .. 30 .. 64
W9ADN .. 38 .. 106	W2OA .. 36 .. 71	W9PGS .. 32 .. 78	W21XY .. 29 .. 86
W9KG .. 38 .. 106	W9ARL .. 36 .. 71	W6NLZ .. 32 .. 76	W3EMM .. 29 .. 76
W8LYQ .. 38 .. 106	W8AQT .. 35 .. 110	W1AB .. 32 .. 76	G6W .. 29 .. 72
LU7AZ .. 38 .. 103	W8OXO .. 35 .. 107	W3C1C .. 32 .. 75	W6EJC .. 29 .. 64
W9PST .. 38 .. 103	W6GHU .. 35 .. 103	W6AX .. 32 .. 74	W9YGC .. 29 .. 64
W9ALV .. 38 .. 102	W8DOD .. 35 .. 102	W9GKS .. 32 .. 71	W21KV .. 28 .. 77
W8QXT .. 38 .. 98	W3TR .. 35 .. 101	W3GAP .. 32 .. 70	W9BCV .. 28 .. 68
VE4RO .. 38 .. 95	W6MVK .. 35 .. 100	W6KZL .. 32 .. 67	VE2EE .. 28 .. 62
G6XL .. 38 .. 89	W8CJJ .. 35 .. 98	W6LPR .. 32 .. 67	W7BVO .. 28 .. 61
W8GBF .. 38 .. 87	W9RCQ .. 35 .. 97	W9DEI .. 32 .. 66	F8VC .. 28 .. 61
W9VDQ .. 38 .. 79	OK1AW .. 35 .. 96	W6KRM .. 32 .. 62	W8QXT .. 28 .. 58
G5YH .. 38 .. 79	W9EF .. 35 .. 94	W6OAG .. 32 .. 56	W3LE .. 28 .. 51
G6RB .. 38 .. 79	ON4FQ .. 35 .. 92	W8BTK .. 32 .. 56	W61KQ .. 28 .. 50
W4AJX .. 38 .. 79	W3GEE .. 35 .. 92	W8HYC .. 32 .. 56	W81AC .. 28 .. 50
W9TJ .. 38 .. 79	W6AQJ .. 35 .. 92	W4MR .. 31 .. 92	W21U .. 27 .. 72
W8KKG .. 37 .. 127	W6MHH .. 35 .. 91	W6DRE .. 31 .. 86	W8LFE .. 27 .. 69
W7AMX .. 37 .. 122	W9RBI .. 35 .. 91	W6GNZ .. 31 .. 85	W6FTU .. 27 .. 63
W6GAL .. 37 .. 121	LU3DH .. 35 .. 89	W8FJN .. 31 .. 85	W8RL .. 27 .. 58
W2GVZ .. 37 .. 118	W8AAT .. 35 .. 87	W2AOG .. 31 .. 83	G8MX .. 27 .. 56
W8ZY .. 37 .. 114	G6QX .. 35 .. 80	W9LW .. 31 .. 82	W9ARA .. 27 .. 53
W6LYM .. 37 .. 111	W9GNU .. 35 .. 77	W2FLG .. 31 .. 80	W6NLZ .. 27 .. 52
	W9QOE .. 35 .. 66	W6KEV .. 31 .. 80	W6GCT .. 27 .. 52
	W2AIW .. 35 .. 66	W2HVM .. 31 .. 78	W9ZTO .. 27 .. 50
	W2IOP .. 35 .. 66	G16TK .. 31 .. 76	W9BBU .. 27 .. 45
	W3BBB .. 35 .. 66		

DX AND OVERSEAS NEWS

Herb. Becker, W6QD

Send all contributions to Radio, attention DX Editor, 7460 Beverly Blvd., Los Angeles.

The "Marathon" now is under way. Many of the boys already have run up a few zones and the year isn't very old as yet. The full details on the "1939 Marathon" appeared in the December issue. Just in case it isn't handy, we'll run over a few points. Beginning with January 1, 1939, and closing December 31, 1939, the "Marathon" is to give the newcomer and old timer a more equal chance to show what they can do.

The object will be for everyone to start from scratch and work as many zones and countries as possible during 1939. A separate list will be shown in RADIO every month, listing the 50 highest scorers for c.w. work and the 25 highest for telephony. This means that one must be active over a period of time if he expects to keep in the list; otherwise from month to month the more active ones may pass him up.

The first list will appear in the April issue of RADIO. The first results will have to be in our office by February 10. The zone map can be referred to for the zones, while the official country list as shown in January RADIO will be the authority for enumerating the countries. The only

requirement to qualify is your itemized list of stations in the zones claimed, and the number of countries. Succeeding reports need only list the additions and revised totals. The list for the "1939 Marathon" will in no way conflict with the present WAZ Honor Roll. This Honor Roll will be maintained as an "all time" record. In this way if you should work a zone which would be a new one for the "Marathon" list and by the same token a new one for your Honor Roll total, you would be credited accordingly. So that the two lists will not conflict it will be necessary for you to show the additions to each list separately with the revised totals of each.

The fact that the "Marathon" covers a whole year will allow you to relax a little and not feel as though you had to work all 40 (?) zones in a couple of months. It's a cinch that during the dx contest you'll knock a big hole in the zones and countries, and it will be interesting to note the change after the contest. So now, gang, it's in your hands and let's see what you can do. Try and keep within that first 50 or 25 of the "1939 Marathon" list.

What About 40 Meters

I just have to get in a plug here for gool ol' 40 meters. It's just a matter of occupying the band, and if you don't think so . . . we'll all get up on 40 from now until the contest . . . which should prove it very well. There have been numerous fellows throughout the States reporting 7-Mc. dx. True, there hasn't been very much of it to work, but what there is has broken through well. Also, some of the boys have made skeds with some of the 14-Mc. dx pals, to get on 40 . . . and when they click, both admit that most of the battle on 7 Mc. is occupation of the band. If we all try to use 40 a little more between now and dx contest time we will be better acquainted with what goes on there when the "hrawl" starts. Think it over, and let's hear about it.

The Brasspounders

W5BB says he knows VS3OL isn't any good. BB has 128 while on phone he can account for 41, VK9VG being the latest. Tom passes along the info that K6HCO, 14,275, from Enderbury Island has moved to Jarvis Island where he will be on the air with the same rig. Of course, there is YS2LR (14,410) who says to QSL via W5FNX, and please to send stamped envelope.

To QSL to the boys who are with the Dept. of

WAZ HONOR ROLL (Continued)

W2HUQ ...27	W2HCE ...23...62
W5DBD ...27	ON4HS ...23...51
G5ZJ ...26...77	W5ASG ...23...46
W2IVU ...26...65	W6GRX ...23...43
W4EQK ...26...61	W9ORL ...23...38
W5DNV ...26...60	W7ALZ ...23...27
VK4JP ...26...32	W7ESK ...23
W6GAL ...26...45	W1JCX ...22...51
W7EKA ...26...45	W8QDU ...22...48
W1AKY ...25...65	W8DBC ...22...46
W1HKK ...25...63	W1KPK ...22...40
W4BMR ...25...57	W6NCW ...22...23
G3DO ...25...56	W7AO ...22
W9RBI ...25...54	XE1BT ...22
W8JK ...25...47	G6DT ...21...53
W6PDB ...25...44	W6NEP ...21...53
W7AMQ ...25...40	W8KWI ...21...50
W6LYM ...25...39	W5BB ...21...41
W6MXD ...25...38	W6FZL ...21...40
W6LEE ...25...34	W9VYD ...21...36
W6FKK ...25...36	W7BJS ...21...37
VK2ABG ...25	W6HX ...21...32
W3SI ...25	W6PNO ...21...30
YV5AK ...24...59	W6OJK ...20...37
W4TS ...24...52	W3AKX ...20...32
W1BLO ...24...50	W6IWS ...20...24
W6LPR ...24...45	W6LOY ...20...29
W6MVQ ...24...36	W6NMI ...20...25
W6MVQ ...24...32	K6KMB ...20...23
VE5OT ...24	W1COJ ...20

the Interior on any of the Pacific Islands, kindly send your cards in care of the Dept. of the Interior, Honolulu, T. H. W5BB has a relative that lives next door whose call is W5VV. It seems that VV has a new signal squirter for 20 up in the air . . . and as he puts it, "and does it work? Heard a W9 on it the other day." Advises me to invest in one. Inside dope from Wilmer's letter indicates he has added PK4, VQ3, YS2, making 132 worked . . . also had to go to the bank to see that blonde. Whatzis, another racket, Wilmer?

W6QAP hooked HK2CC and GW3JI for new ones and W6CVW also in Tucson grabbed FA8BG. W9VKF has built himself a Dream Transmitter. It uses an 814 in the final and is absolutely two knob control. With his new rig he worked two new zones, VQ3HJP and TF5M. I mentioned this Dream Transmitter to a local ham, and he said, "That's nothing; lotsa guys have told me that my rig was a Nightmare."

VQ8AI asked W5EUL to forward a bit of information to us relative to his QTH. The correct QTH of VQ8AI is as printed in the Callbook, which is, L. G. Raoul Thomas, Thompson Road, Vacoas, Mauritius. It is not necessary to send your cards via anyone else . . . simply direct to VQ8AI. W9TJI joins us with 33 and 76 countries, including F18AC, TF3C and U8IB, U8ID and U9ML.

W2GT has accumulated 143 countries and 38 zones, and among them are CN1AA, YS2LR, ST6KR, TG9BA, G6IA, VQ5ELD. 2GT says that ZS3F is moving and at his new location, which is about 180 miles away, he will use low power and directive antennas. TG9BA is installing a new rotary antenna, and when he finishes he has promised to go on c.w. to give the c.w. men a break. Incidentally, the correct QRA of TG9BA is Walter C. Bay, Chalet Krolik, Guatemala City. This from W2GT. W9YEG adds VU2FX for new zone. W9GKS has 31 and 70 to his credit.

W6ONQ has been pounding a little on 40 lately and has worked LU9CK, PA0EA and FA8BG as well as J, VK and ZL. He has heard a number of others, too. John has 34 zones and 72 countries. G2QT had been having a heck of a time trying to work a K6 until recently when he put up an antenna directed on them. He raised the first one he called, which was K6QIU. Other new countries are VP9G, VP8AD, VQ3HJP, VP4TO. Frank now is 37 and 103. W8AU finally got those 60-foot poles down out of the mountains and has three of them up to form a triangle. Lou has hung three 8JK antennas up, giving fairly complete coverage. He had to take down his long wire that ran over the neighbors' backyards, because they thought it soaked up too much "juice" from broadcast stations. Now with a lot more wire in the air, and all on his property they can't

say a word, although Lou admits there are plenty of dirty looks around.

W7AVL is still getting them and this time it's LA6U, LA7C, ZE1JI, TF3C and YV5AE, making 34 and 76. W5PJ is added to the gang with 34 zones and 78 countries. Another new one is W2BZB with his 31 and 75. BZB has worked these stations quite recently . . . PK4KO, VU2LK, G8MF, TF3C, VQ3HJP, F18AC and ZC6AQ. Rig is a pair of 35T's with 300 watts input. W9CWW is back again to say that he has added a few which include CR7AG, CR7AF, VP7NU, VP9X, VQ8AS and HI6Q. A friend of Charlie's, W9VWV, who also is in Leavenworth (Kansas),

FREQUENCY LIST

The frequencies listed below are taken from the stations you will find throughout the dx section. Rather than show the frequencies after the call we feel it better to list them separately for easier reference. The frequencies as printed are only approximate, and where a station is reported by a number of contributors, an average frequency is used.

C. W.

CN1AA 14.408	VP8AD 14.380-14.410
CP1AA 14.415	VP9X 14.300
CR6AI 14,100-14,060	VK9VG 14,100
CR7AY 14,100	VK9BW 14,380
CR7AF 14,275	VQ2MI 14,330
FA8ZZ 14,405	VQ2PL 14,425
F18AC 14,410	VQ3HJP 14,405
G6IA 14,050	VQ5ELD 14,045
HK2CC 14,135	VQ8AI 14,320
HS1CK 14,020	VQ8AS 14,290
KD6QLS 14,040	VU2AN 14,055
KF6DSF 14,395	VU2FO 14,340
K7FST 14,395	VU2LK 14,001
J8CG 14,410	VU2FX 14,340
J2KG 14,410	VU2BG 14,250
LZ11D 14,400	VS6AS 14,130
LZ3AB 14,405	VS6AG 14,385
PK1TT 14,250	XU3AA 14,075
PK4KO 14,120	XU4XA 14,270
PK4KS 14,320	XU9NT 14,240
PJ1BV 14,410	XU9FS 14,210
ST6KR 14,310	YS2LR 14,412-28,000
TG9BA 14,005	ZB1R 14,306
TI2LC 14,420	ZC3D 14,370-14,420
VP7NU 14,300	ZD2H 14,312-14,100

PHONE

CN1AF 14,110	PK4KS 14,310
CN8DA 14,075	SU1RD 14,300
F18AC 14,410	SU1MW 14,100
FB8AH 14,350	SU1AX 14,010
I1MY 14,020	TG9BA 14,005
K7FST 14,160-14,200- 14,208-14,219	VK9VG 14,100
OH2OI 14,188	XZ2DY 14,245
OZ5CN 14,270	ZB1L 14,040
	ZL2Q 14,248

breaks into the zone list with his 31 and 60. VWV uses two half waves in phase headed toward Africa and has done a good job cleaning up those zones. Another addition which we welcome is G6XL, who has been pounding brass for a long time. His list of 38 zones and 89 countries bears this out. The ones he lacks are zones 19 and 23.

VK6 QSL Cards

A note is received from "Transix," an organization of hams in Western Australia. They point out that due to the 1800 miles separating them from the QSL Bureau of VK3RJ, they feel it beneficial to all concerned to have a bureau in Western Australia to expedite forwarding QSL cards. Therefore, you may send your cards for VK6 to: Mr. J. Mead, VK6LJ, 39 Canterbury Terrace, Victoria Park, Western Australia.

W1AQT worked ZD2H for his 108th country. Says the J's are coming through in the afternoons but can't seem to raise them. Bob also says that E14J and E18B will probably be around next year for the Fair . . . and a bit of hamming. W2GTZ hooked up with about 125 Asians during 1938. A few new countries for Reeve are CR6AI, VK9BW, TG9BA and G6IA . . . now 141. W4ADA says that due to the scarcity of W4's in the Honor Roll, he felt he would add his bit . . . with 36 and 90. He claims he doesn't run a California kw., but does have 750 watts sometimes to a pair of 35T's. Some of Pete's best dx includes FB8AB, VQ8AB, VQ4CRP, VU2FH, PK3WI, ZC6AQ, J2CL, J2KJ, J3FP, K6OJG. W9YNB has been doing himself some good and before long he will have his 30th zone. Newest for YNB are PJ1BV, GW3JI, LY1KK, U2NE, CT1CO, FA8RY, ZD4AB, VK7JB, VU2FX, YV5AE, LZ1ID, YS1A and CR7AF. W2BJ pops up from practically nowhere with a few new ones for him: ZD2H, CR7AG, GW3CR, CR6AI and G5UG, Isle of Man. Ray now has 36 and 117. W9QOE worked a couple of stations signing VS5AG and CR8AF . . . and we wonder who knows about them. Latest for Bill, however, are VS6AG, TI2LC, YS2LR, VU2FX, VU2FO, CP1AA, OA4Q, K6DSF and TF3C which all help 9QOE up to 35 and 66.

W1HE isn't on the air himself due to rebuilding, but when he went down to the Bridgeport DX Roundup, he visited W1APA's shack and knocked off J8CG for him. Not bad at 2:50 a.m. From all reports the DX Roundup was a success and the next one is to be in New York City.

The boys say they fixed up W1AQT, and from the description . . . I'll say they did. But I'm not saying any more . . . you'll have to work some of that W1 gang and get the details. A word is received from ZS1CN ex-ZU1T. He has now accumulated 34 zones and 82 countries. After 11 years ZS1CN finally got his first ZL . . . and another point he brings out is the fact that when he

sends out a directional CQ for Nevada, he gets so many replies that one would think Nevada was the easiest state to work.

From W8OSL we learn that W8HWE, "Race" Haas, is back at it again and has grabbed off two new countries in VP9X and G8MF. OS� also says that W8CRA is having incredible luck with his two new antennas . . . which I think are two half wives in phase. A short time ago I asked W7BB to get his rig going again and see what he is missing. He says it's impossible because he is on the road most of the time, and very seldom home to pound brass. He did look in his logs to find that he has worked 39 zones and 123 countries . . . and get this . . . 117 countries that he worked were on 7 Mc., 5 on 14 Mc., and 1 on 3.5 Mc. How's that?

The story of ON4HS is a little different. The name is H. S. Simmons (a few W's call him Ham Sandwich) and he is an ex-service man living in Belgium. During the war he drove a field ambulance during the time when the big "stuff" was flying night and day. After the war he was on the air in France and then moved to Belgium in 1925. After much persuasion and red tape he was allowed to take the examination and now holds ON4HS.

Mr. Simmons has been most active on 75-meter phone during the past but now is doing some 14- and 28-Mc. work. On 3.5 Mc. he has worked 9 zones while his total on phone is 23. Some very fine contacts were had on 3.5-Mc. phone, among them W9LIP, VE1EI, VE3TJ and VE1GR. ON4HS has probably spent more time on 75 meters than any other amateur in Europe. There have been many days when he has kept watch on the band trying to break through for a single dx contact. He probably would be able to tell us all a little about this band which we have never heard before.

The new rig at ON4HS will be 47 oscillator, 6L6G buffer, and a T55 final with about 50 or 75 watts input. By the time you read this he should have it going and you might give him a call. Simmons also says his "G" handle is "Haggie Sausages" so you can take your pick between that and "Ham Sandwich" when you work him.

It is with deep regret that we inform you of the passing of Vic Gettys, W8EJ. He was killed when his safety belt broke while he was installing a new device to prevent the formation of ice and sleet on the antenna of the police radio station in Youngstown, Ohio. Vic was very well known and was very active pioneering dx work. He also supervised the building of WPDG, which was the seventh police radio station installed in the country by a municipality.

G6WY is at it again and has worked his 151st country in YS2LR. Ham also worked K7FST . . . but no, he wasn't in zone 19 . . . he was still in Alaska. W4DMB adds YS2LR and U8IB.

W6MVK has 34 and 99 with some new ones being KG6NVJ, LZ3AB, ZC3D, G8MF, TF3C, ZE2H. MVK says ZC3D is on 14,370 and has been in the present location for six months, while his home station is ZD1D. I hope it's true. W3GW has now 137 countries, while on phone he has 31 and 65. W5KC does a little himself by logging VQ2PL, F18AC, PK4KO, XU3AA, VQ3HJP, PJ1BV, ZD2H, ZB1R, CR7BC.

K6MV passes along the news to W6CUH that KD6QLS will be on the air at Midway Island sometime during February. Frequency about 14,040 and will use a 6L6. KF6NVJ on Jarvis says that VR4AD will be off the air for about seven months.

W5ASG has a few good ones . . . CR7AF, U5KN, VQ3HJP, ZD2H, YS2LR, VP3AA, VU2LK. W9GKS has VQ2MI for his 32nd zone. W6TI also worked ZC3D, who is supposed to be on Christmas Islands, VP8AD and YV5AE for new countries, now making him 80. W3DUK worked a guy on 7225 kc. who signed UH1AA and gave this as his QTH: L. Somerset, care of British Army, Lith, Hedjaz, Arabia. You draw your own conclusions, and we'll hope for the best. DUK also wants a dirty dig in for W8AU. I'm not going to stick my neck out . . . at least not now.

W9VDX landed TF5J on 7142 kc. and hopes he's OK. We should start a "hoping club" and everyone contribute his questionable ones; then every member will hope for the next guy . . . but it won't be fair to hope for yourself. W3EPV has jumped up quite a bit since last heard from. Now has 38 and 121 with the new ones being J2KG, J2NF, XZ2KR, F18AC, K6OVN, KA1FG, ZD2H. W6MVK is in again with FA8ZZ for his 35th zone. VE1DR breaks into the list with his 36 and 98. W9GBJ just hooked his 90th country who was VP8AD . . . zones are 34, and his rig runs 350 watts into a couple of 35T's. W7FD heard a certain ZS6 working a W1 and signed off with, "Well, must QRT now and go to work *@#%& it." Hi. Time 8:30 p.m. p.s.t. W1APA and his new rotary 8JK is going to town. Worked F18AC right off the bat and was so tickled he settled right down to serious work and when he wound up he found he had KA1FG, TF5G, SU1SG, VK6AF, VP7NT, HH2MC, G2OU CX2AJ, XU8NR, J8CG, K6MVF, K5AG, OY4C, XE1AM, YR5ML well salted away. About that time I think his x.y.l. salted him away.

W3EVW was a little irked when he almost made w.a.c. in 59 minutes. The only catch was he couldn't find a South American contact. That's the trouble, there's always something to take the joy out of life . . . but with Rog the week wasn't altogether lost as he hooked VQ3HJP, PJ1BV and YS2LR. W7GMH had a funny experience the other night. He was working W6LI and had a fine chat and then signed off. Within

a minute or two after W7GMH signed with W6LI he was tuning around the band to hear W6LI working W8GMH . . . W 8 G M H. Of course, W7GMH thought possibly he had been into that XXX, but such was not the case. Thus endeth my little bedtime story.

W6GK had been trying to QSO an SU for two years with no luck, and then all of a sudden he grabs SU1SG, SU1WM and SU1AX . . . all within six days. Others for George worthy of note are FT4AG, CN8MJ, ZB1R, VQ3HJP, VQ8AI, ZS3F, VP2LB, VP2AB. Now has 33 zones and 94 countries. Gee, maybe if QD waits long enough a whole flock of stations in zone 21 will pop up. Yoo hoo, VU2AN. W2GVZ drew a bead on J8CG and now has him safely logged for country no. 118.

Now look who's here . . . it's W1RY . . . and he's still on the air. Yes, and he now has 36 zones and 104 countries. Some new ones for Rog are YV2CU, VK9VG, ZD4AB, ZD2H, VU2AN, VU2FX, CR7BT, CR7AF, CR7AY, J2KG, ZB1J, YN1HS. Rog says he is still using the 201A blooper and his rig winds up with an 808 in the final. His antenna is an 80-meter zepp which runs over two houses, through a tree and is parallel to the power lines. Says he is vitally interested in collecting pre-cancelled U. S. stamps, and can give references. Hi.

A short time ago while down in San Diego to a hamfest I met a couple of ol' timers who used to grind it out in the spark days. One was 6KC and the other 6AUB. Both have other calls now; the former is on 5 meters while the latter uses 160. Each was speaking of his dx, but AUB who is now W6MKW, won the honors with his wild story of how on 160 meters he worked W6MRF in Huntington Beach, a distance of 80 miles. On spark he used to work about 500 miles, through crashes of static that sounded like some of the signals on the air today. This is the first time any 160 meter (dx) has appeared in here, and I think it will be about the last . . . but then again, you never can tell. F18AC told W6PKA that CR9A is the Chief of Police and was on the air once in awhile with his 5-watt rig. I think it must be the police job.

Calls Heard

For those desiring to submit lists of Calls Heard, you are asked to mail them to the "Calls Heard Editor," 7460 Beverly Blvd., Los Angeles, Calif. They preferably should be typed and in numerical order, as well as alphabetical, though this is not required. When compiling these lists you are urged to use the "R" strength suffix directly after the call. Example: W—1AQT-7; 4DMB-6; 5BB-3; 6QD-1; 9CWW-8 . . . etc. These comparative reports will add usefulness to the Calls Heard column. It will be of especial interest to the newcomers who have not been after dx long

enough to know how they are getting into a distant location.

With the Phone Men

5CXH, "This is the Mouth of the Mighty Mississippi," says CN8DA can be found around 14,075 kc. and VU2CQ on 14,120. It's good to hear that W8BYU is in good standing again after renewing his license . . . which he had forgot to renew. W1JCX has been doing something to get his totals up to 22 and 51. F8UE is a new one to the phone list with his 33 zones and 95 countries. F8UE uses a PR-15 and the antenna is an 8JK rotary. His final holds a couple of T55's, running 300 watts. W1HKK had quite a trip to Europe this past summer and visited G2TR, G6BY, G2PU, G6CL, G5JO, G2XU, HA8N, HA1P and G2PL. Upon returning Dana has done a certain amount of rebuilding which includes his rig now using a pair of HK54's with about 700 watts input. Receiver is an SX-17, and for antennas he has four beams on 70-foot poles. The whole layout is controlled by many relays and is push-to-talk. Zones now are 25 and countries 63. Newest to his log are ZL2JQ, SU1MW, SU1RD, CX1BK, CE3BK, LA6N, LU4DJ, I1MB.

ON4PA

W9VWL has a weekly sked with ON4PA on 10-meter phone. The parents of VWL have been visiting in Belgium for several years and happened to be at the station of ON4PA, when one of these skeds ran off. This was an absolute coincidence and needless to say both "Mother and Dad" on one end and "Son" on the other were greatly thrilled to hear the other's voice. W6GCT has been neglecting his c.w. work somewhat but has a few new ones on phone. They are GW8HI, EI2L, YG9BA, which makes Henry 52 countries. W9BCV is also up and at 'em with these for proof: VP1BA, TG9BA, XU8CM, VK7RZ, K5AH, PK6XX, CN1AF, VP7NS, VP3AA and GW5TJ

W2IXY worked OH2OI (14,188 kc.) for her 86th country. QTH of OH2OI is Viarkkala, Finland. W9NLP picked off XZ2DY for his 33rd and 74th country, and now is gunning for VU2CQ. W2IUV went up to 27 zones and 69 countries by clamping down on ZL2JQ, VP7NS and CN1AF. W6OI found himself working SU1RD the other day, which gives him 30 and 66 . . . and K6ODC on Canton Island helped, too. W6OI says he is to be visited by W7BVO and hopes he can hook a couple of juicy rare ones while Rolly is there.

Have You Seen ZS6AA?

W8JLW reports ZS6AA to be in USA somewhere, but none of us out here has seen him yet. Have you? W6FKK went to the convention out here and went home with fire in his eye. Before he had cooled down he had 3 new zones to his

credit: CE2BX, PY2DA and VQ2HC. This gives Rod 25 and 36.

W8LFE has been on 20-meter phone for quite a while and his latest are VQ2PL, VQ4KTB, K7ACC, G61A, VK9VG, VK9WL, PK1VM, PK4KS, XZ2JB, VU2BG, FA3HC, FT4AN. W4AKA writes for the Clearwater Radio Club's station W4EQK. They have a very fine setup using an eight-wave V beam for Asia and two small rhombics for Europe and Africa. Two HRO receivers with preselectors are in use, while the rig ends up with a pair of 250TH's. On phone they have worked 26 zones and 61 countries, while the total for c.w. and phone is 36 and 99. F8VC can still find some new ones and this time they are PK4JD, NY2AE and SM2VP; this makes Gene 28 and 61.

W7BJS in Afton, Wyoming, can't seem to get above 21 zones no matter how hard he tries. He has had about 70 skeds with G6BW and 142 contacts with Europe on 10-meter phone . . . since October. W3LE says he is credited with working too much dx as shown in December RADIO. We ran the following as worked . . . when they were in reality just good ones heard: FB8AH, SU1MW, SU1AX, I1MY, OX5BW and ZB1L. Sorry, Lou . . . but I hope you land them all.

W8RL Back Again

W8RL (roaring lions) is back again after a little layoff. Charles says they have reduced power and work out just as well; they are still 100% phone on 20 meters. Totals now 29 and 64. G6BW has two new ones in TG9BA and CX2AK making 29 and 72. W6IKQ is up to 28 and 50 and his new stuff includes HP1A, HH2B, CN5NW, VS7GJ and VP4GA. W6OCH had good contacts with VP7NS and VK7CL which gives Larry 34 and 87. He is at present hot after K7FST when he goes to East Cape.

W2AZ has just worked his 100th country on phone. His zones are 37 and some of the latest for 2AZ are G8DO, OH1NP, ZD4AB, D4ZZH, ZD2H and VP2LC. W2AZ uses phone only and his frequency is always 14,176 kc.

G5SA

G5SA is back home and in a letter Dave says that his old rig worked so well that he thought he wouldn't need all the gear he took home from USA. Remember, G5SA was out here in Hollywood for several months. One of the first he talked with after returning, and firing up his rig, was W6PDB, our staff "artiste." K7FST may be reached by addressing Charles W. DeRember, Kotzebue, Alaska. He said he would be making the trip to East Cape the second Saturday and Sunday of February and March. Phone frequencies are 14,160, 14,200, 14,208 and 14,219; c.w. will be on 14,395. He says CQ on phone at 3, 5, 7

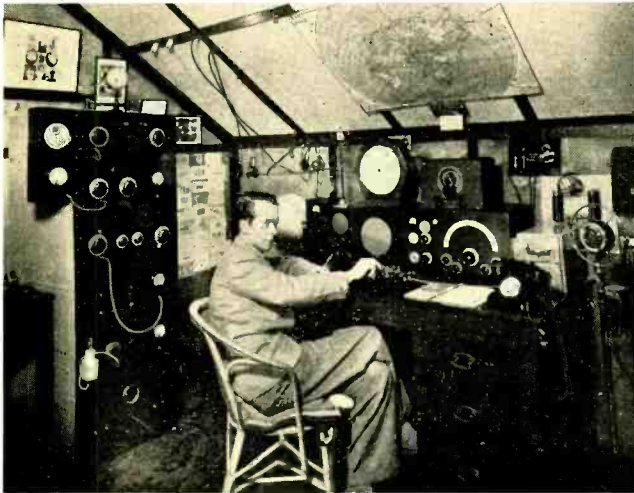

G81C, the station of C. G. Allen, uses a T55 modulated by a pair of 210's in class B. Several directional antennas are used, and Allen has worked 32 zones. The receiver is a converted b.c. unit, used in conjunction with a two-stage preselector. Most work is on 14 and 28 Mc.

and 9 p.m. P.s.t. and on c.w. at 6 and 8 p.m. P.s.t. This will be during those week ends. Anything further from him in the meantime will be passed on to you.

Frequencies, Zones and Countries

Fellows, when you send in your "bit" every month, try and list as many frequencies as possible of the stations you show. When they are compiled into the Frequency List this will help others to some extent. It is true that by the time they appear in print some of the dx stations listed have changed their frequencies, but in a great many cases it gives a lift in identification. Not all of us log frequencies when we hear these elusive birds, but any that you can send in will be appreciated by some of the gang, I know. For those who have no idea what part of this old world is in any one zone, I might get a little commercial and say that we have a good Zone Map that you can obtain for twenty-five cents. The map will be mailed anywhere for this amount, which just covers the printing and mailing costs. It is sent in a mailing tube so as not to wrinkle it.

About countries . . . it might be a good idea to grab the January issue and check over all your countries to see if you have left out some or for that matter, counted some which have of late proved to be NG.

W6USA

I think it should be mentioned again that W6USA will be located on Treasure Island at the Golden Gate International Exposition in the San Francisco Bay. According to the Director of Publicity of the Amateur Radio Exhibit, W6TI, some very attractive QSL cards will be sent out to every station worked. All cards will be answered. W6USA should be in operation very soon.

Hold De Phone

When you're tuning around the 10-meter and 160-meter phone bands and you hear W6QUT, you should recognize the voice . . . perhaps. If it happens to sound like Amos Jones of "Amos 'n' Andy" . . . that's right, because just a few days ago Amos, or perhaps we should say Freeman Gosden, received his ticket and expects to be on the air by the time this is in your hands. The rig is a remote controlled job, but more on that later.

Turn for the Better

Most everyone has been complaining about such lousy conditions . . . that is, until just recently when things took a turn for the better. The mornings are getting to be swell and in the early evenings there is a definite trend toward better dx. Let's hope it will keep up. Things around the shack of W6QD have been held down to almost a whisper, although during a 28-Mc. QSO with G2PL I found that he now wants a photo of Dorothy Lamour. Pete says he thinks Ginger Rogers is still OK but that Dorothy Lamour "has what it takes." About two years ago G2PL received a photo of Ginger, and his pals were envious.

When you read this W6QD will no longer be located at good ol' Manhattan Beach. A new spot has been acquired in the city (meaning Los Angeles). Incidentally, never use that term "spot" when speaking to the x.y.l. of a new house. There is a slight flavor of "ham radio" attached to it. Just how long before the brass will be pounded again depends upon the success of a pole raising "bee" to be staged. There is a nice vacant acre adjacent to this "spot" which before long will be covered with a maze of wires up in the air . . .

[Continued on Page 83]

YARN *of the* MONTH

BRASS WIDOW

Joe is a tall guy with a bald spot and an amiable disposition. You'd never look at him twice unless you knew his wife was in love with him. And for that to mean anything, you'd have to know his wife.

Dorothy is one of the few gals that make the world worth inhabiting. You're sitting parked somewhere in your hack, waiting for the missis to do a minute's shopping in half an hour, griping at things in general, when Dorothy strolls across the street or up the sidewalk. Right away Humanity, Preferred, jumps five points.

She could have married any one of fifty assorted football stars, captains of industry, college professors, explorers or elevator operators. But no, she had to pick on Joe, who is first a radio ham and merely earns a living in his spare time.

What with these all-wave radios they're peddling now, you've probably heard all the blatin' that goes on wherever the dial reads "Amateur Band." Well, that's Joe, except he has his say by pushing a key up and down instead of talking with his face. All of which is highly unintelligible to Dorothy, but as a bride of a week or so she thinks it's cute as the devil and is tickled to death that her sugar-plum is so brainy.

This attitude allows Joe to relax and in no time at all after their marriage he's right back hammin' as hard as ever, his conscience clear and his wife relegated to the radio-widows' limbo—whatever that is. Or so it seemed to us—meaning my wife, Sue, and me. But subsequent events proved there was something more there, between those two, than met the probing orb. It was like this:

Discounting other radio nuts, they never had many close friends. People would visit them and find Dorothy curled up in a big, soft chair in the living room, reading a book, with Joe out in the radio room working his rig.

Dorothy was just as sweet about Joe's peculiarity as anyone could want, but folks

got tired of waiting while she called "Joe," three or four times until he heard her and took the headphones off and said he'd be out as soon as he finished working this guy. And then sometimes he'd forget about it and she'd have to go in after him about a half hour later.

But we always went back. I don't know why, since they never came up to our place or went out at all. I guess it was because we were sorry for Dorothy and you couldn't help liking Joe too. Every time we showed up it was the same ritual of extracting Joe from the ham shack, and to all appearances Dorothy didn't even notice it. She was always curled up in the same chair with a different book and would call, "Come in," gaily, instead of getting up to open the door. Then she'd jump up, tickled to death to see us. Every movement she made was a rhythm of breath-taking beauty, and after we'd been there a few times I learned to try and get inside before she jumped out of the chair. It was a sight worth watching.

When Joe came in we'd play a rubber or two of bridge, and around ten Dorothy would trot out some eats. After stowing the grub where it belonged, Sue would say something conventional about how we had to get up early and had better go home and to bed, and Dorothy would get our wraps. Joe would look at the clock and guess he'd work a little dx before he turned in, and as we chugged away we'd see lights go on in the bedroom and the radio shack. It was always the same. Sue would think about Joe and say it was terrible for a man to treat his wife that way, and I'd think about Dorothy and agree that it sure was.

This sort of thing had gone on for about two years when it happened. Right out of a clear sky, without even Sue smelling a mouse.

Joe showed up at our place one night, alone, and a more dismal looking guy I've

[Continued on Page 83]

By LUDLUM SMITH

POSTSCRIPTS...

and Announcements

Ten-Meter Auto Converter Alignment

In aligning the u.h.f. auto converter described on page 52 of the January issue, care should be taken to avoid peaking the detector trimmer so that the 10-meter band is covered on an image. The latter condition can occur if the set is aligned only by background or auto ignition noise. To avoid this, the converter should first be trimmed while listening to a local 10-meter signal. This will eliminate the possibility of peaking the trimmer to the "wrong hump." When this adjustment once has been made, the trimmer can be touched up accurately using the background hiss or auto ignition from your own car as a signal.

If trouble is experienced with slow heating of the 6J8-G (due to excessive drop in battery leads or a low battery) a reduction in the heating time can be had by substituting a 6K8. Operation of the latter tube is much the same except that the oscillator section seems a little more "lively" and heats more rapidly. No changes in socket connections are necessary.

Foreign QSL Postage

Many amateurs send international reply coupons when soliciting a QSL card from some elusive dx station who doesn't feel inclined to buy stamps for QSL's. Sometimes it is more effective to enclose a stamp of his *own country*, so that he need but put it on the QSL card. It is cheaper, too, if you don't have to pay too high a premium for the foreign stamps, because reply coupons are based on the *letter* rate and most QSL's are mailed as postcards, the rate for the latter being appreciably cheaper in many countries.

Stamps of postcard rate for most any foreign country may be obtained from Walter H. Koester, 85 Francisco Ave., Rutherford, N. J. A price list is available on request.

Cover

The strange looking contraption on the front cover is used for locating the source of cosmic or interstellar noise with a high degree of accuracy. The black object on the top of the 410-gallon drum is the 1.93-meter concentric line-tuned receiver described in the January issue. Except for a small hole facing the parabolic reflector the drum, which is a resonant chamber, thoroughly shields the receiving antenna inside. The reflector, which measures 30 feet across, acts as a collector and shoots the signals into the hole in the bottom of the drum.

With the "sky scanner" in a fixed position it is possible to hear the star *Antares* whiz by in about two minutes. The array itself has elicited considerable comment from spectators, most of them suspecting that it is an experimental direction finder for airplanes rather than for static. Grote Reber, W9GFZ, is responsible for the weird affair, E. H. Conklin for the photograph.

January Cover

The front of the January, 1939, issue showed the 200-watt 56-Mc. amplifier described in that issue delivering a nice juicy arc, the customary lead pencil acting as "bait." The only light used in taking the photo was that from the arc and from the tube filaments and plates, the latter running white hot while the arc was being drawn.

Hamfest

The Rochester Amateur Radio Association will hold its annual banquet and hamfest, Saturday, Feb. 4 at the Seneca Hotel, Clinton Ave., South Rochester, N. Y. Tickets are two dollars. A turkey dinner will be served at the banquet and registration begins at four p.m. Advance tickets or any further information can be obtained by writing Mr. Wm. Hamp, W8HZD, 194 Forgham Rd., Rochester, N. Y.

Calls Heard

Reports of calls heard are always of interest to most of us, and especially so in the case of DX men, operators of experimental "X" stations, the 1939 Marathon participants (see Jan., 1939 RADIO) and those operators who spend most of their time on the ultra-high frequencies. Remember that many newcomers will also welcome "heard" reports to guide them in their search for new DX.

For details of submitting your reports, please see page 64 of this issue.

Which Do You Prefer?

A recent questionnaire was sent to readers as to whether they preferred any particular issue to be the annual issue, but the results were indecisive; January, October, and December led the parade. If your grid has a strong bias in this matter, won't you kindly let us know?

56 MC

By E. H. CONKLIN*

From everywhere, this month, we are receiving comments on the new stabilization regulations for five meter transmitters. Some winter drift to lower frequencies generally takes place—just why, we don't know—but this time the band in many cities has gone almost completely dead. Those who like the ultra-highs but who will not or can not stabilize, are moving in large numbers to 112 Mc., which leads us to start a new column for that band, to be continued temporarily to see if there is enough news to justify it.

Sporadic-E DX Again

While the sporadic-E layer is found mainly in May through August, there are occasional hours in which strong reflections are encountered in other months, particularly evenings. The Washington measurements showed little of interest in September, but there were a number of hours during October when 56 Mc. dx may have been possible. Actual communication took place in December.

Dawson, W9ZJB, reports from Kansas City that for five minutes at 8 p.m. on November 27, ten fast fading carriers were heard on five meters during a period of short skip on 28 Mc. On November 29, W9AEQ heard twenty meter harmonics of a W6 in Arizona, a W5, and others not identified.

December 10 and 11 were good for short skip on ten meters, some fellows staying up all night to work as close as 250 miles. On Sunday morning, the 11th, W9SQE heard the short skip at 9:15 a.m. Central time and shifted to 56 Mc. to work W1EYM, W2DB and W3EZM. W1EYM says he also worked W8JLQ. W9NY was reported as being called.

In Kansas City, W9ZJB heard fading signals at nine o'clock, identified W2DB and W2BUR about ten, W3EZM called W9SMM who couldn't hear the dx so ZJB relayed. W3GQS and W2HWX were heard before the band closed at 12:15 p.m. W9ZD found that the band closed a half hour earlier on the superregen than on ZJB's superhet.

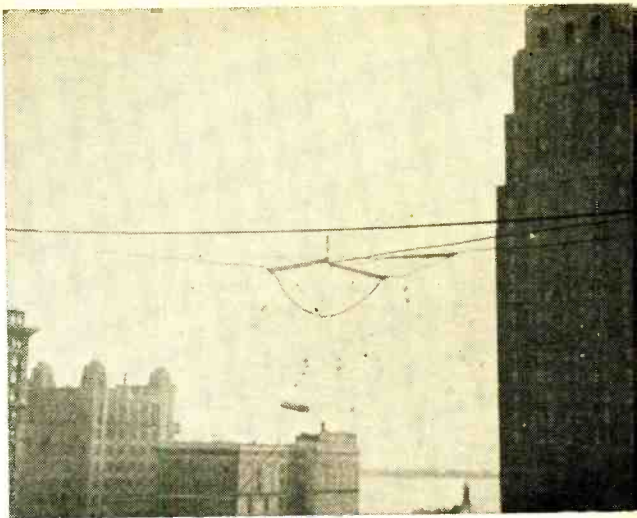

Whenever VE3ADO shows visiting hams his antenna array, they also get this view of some of Toronto's sky-scrapers against Lake Ontario in the background. This photo "looks" towards Buffalo and Rochester, N. Y.

W5ALK in Fort Worth was overheard on "ten," by W9QDA, saying that five meters had opened.

Conditions were apparently quite good for this "off-season summer dx" but with only a few stabilized signals on the air, there were no complaints of QRM!

Chicago-Boston Relay

The relay, announced last month, is threatened at least on January 1 by an inability of numerous stations to comply with the new regulations by that time. Many have embarked on major rebuilding programs which will not be completed. We may have better luck from that standpoint on February 22.

There are still some gaps that will be difficult to bridge. We haven't solved the Syracuse-Schenectady jump yet. There is also a gap across Pennsylvania from Allentown to somewhere east of Pittsburgh, though W8QJP and W8OKC can cover part of it. In the southern route, Hagerstown, Maryland, to Washington, Pennsylvania, requires some portable operation. We had hoped to avoid the use of portables on mountain tops, which is one thing that permits winter attempts, but unless the messages are going to be delivered next summer, we'll have to use c.w., portables, and any other aid short of a QSY.

It is hoped that some messages will be able to get across a good distance. Chicago to Syracuse or Hagerstown would be a record anyway. As it stands now, the route to Syracuse is about as follows:

W9CLH-W8CVQ-W8NZ - W8CVR - W8IUD/
RHF-W8MDA - W8QDU/NKJ/LJP - W8GGA/
KOL/VO-W8TT-W8QKI - W8BKM - W8GU/
NBV-W8GBK-W8RV/NOR-W8PLQ - W8AGU -
W8PK-W8DSU—?—W8JHW-W2KLZ-W2HZL/
AMM-W1EFN-W1JDO-W5CSU/1.

Over half of the above can be hopped over in any sort of favorable conditions. The Pennsylvania route is the same to Cleveland or Akron, and then it goes southeast:

W8VO-W8PWW-W8CIR-W8NED.

Here it may go east via W8QJP-OKC-W3BYF-W2AMJ until the mountains stop it, or south through Washington, into West Virginia and to Hagerstown but this hop last October required some portable work—and W8CIR says that the hills are sometimes slippery; we recall a few signs to that effect along U. S. route 40.

If the January 1 and February 22 relay attempts are promising, and if the gang wants to try again in the late spring, we shall organize one or two additional tests. A lot of the detail must be handled by mail, so let's hear from you.

International Tests

At this writing, it looks more and more like the dx tests proposed for last November should have been held in the same month of 1937. G2YL says that they were a washout in England. G6DH says that the maximum frequencies heard have regularly been less than in the same month of the previous year. The National Bureau of Standards' measurements for maximum usable frequencies reported for Wednesday noons fell short of 50 Mc. in every case, though it included the early winter peak:

Date	Max. usable frequency
October 26	30,500 kc.
November 2	40,500
November 9	47,500
November 16	47,000
November 23	42,000
November 30	39,000
December 7	40,000

British Notes

Radio magazines in Great Britain differ considerably from those in this country. Almost any amateur publication there will contain a good record of conditions on each band, while here it is quite difficult to find out how things were, on any frequency, at any time in the past. We don't seem to pay as much attention to reporting conditions.

A British 56 Mc. test was carried on last September 9-11, with interesting results. The best distances covered in QSO's over 100 miles were between fixed stations rather than ideally situated portables. Some of the longest distances over which signals were heard, were covered by using 40 or 80 meter horizontal antennas for receiving, but these had to be lined up accurately because they become quite directional at high harmonics. 2DFG, operating portable, heard G6LI, 166 miles, five times. He heard G6FO, 132 miles, eleven times. A police phone 230 miles away was logged. All this was on a 135 foot antenna. 2AAH, also portable, logged G6LI, G6FO, and G6VF at 166, 110 and 96 miles. There were quite a few additional reports at distances over a hundred miles.

Eureka!

All this talk of 50 to 200 mile dx brings up something else. Lots of fellows who have heard loud 1000 mile signals on five meters are misled into thinking that their receivers and antennas are "hot." They may have heard nothing else beyond twenty miles. Quite often we hear from someone who has solved the 50-200 mile consistent dx problem, telling us of the thrill. W3BYF in Allentown, Pa., writes as follows:

"Just a bit about 56 Mc. here in the Lehigh Valley which is surrounded by mountains (or hills) on all sides. I have after four years of endeavor finally during the last year licked the line-of-sight business to a frazzle, being able to work stations around Philadelphia, 55 miles south and over a hill 300 feet higher than my antenna, almost any time of day or night.

"Also, I can hear W2AMJ, 135 miles north-east, practically any time he is on but don't work him often because of QRM at his location. Lately, there has been quite a bit of low atmosphere bending, allowing other W2's and some W1's to come through here.

"The antenna is a single section 8JK vertical, rotary and fed with concentric line. It really works well although during the summer dx it didn't make much difference which way it was facing. The receiver is a Jones five meter Super-Gainer, with an 1851 r.f. stage which improved it immensely. A commercial receiver tested alongside mine was about the same on an R9 signal but because of the different signal-to-noise ratio, an R6 signal on mine couldn't be heard on the commercial job."

The signal power in the antenna due to this 50-200 mile sort of dx depends on the field strength that the distant transmitter lays down, the height of the receiving antenna, the antenna itself, transmission line, coupling to the receiver, and the set. All these should be checked carefully. Some users of superregen receivers have used loosely coupled antennas because the oscillation would cease with tighter coupling, whereas the signal might be stronger if more coupling is used and the oscillator whooped up. After the input power to the first tuned circuit has been determined by the antenna, etc., the signal-to-noise ratio depends on the gain that can be produced in the first tube, which is greatly affected by the tuned circuit. These three-turn coils and the like must indicate poor efficiency. If a coil and condenser are used instead of a concentric line or another type of high-Q circuit, the least one can do is to see that the coil is a good sized one. In many cases, the loading effect of the tube can be reduced by tapping the grid down on the coil to the point where a test signal produces the most output—but the largest possible coil should be used for each adjustment of the

grid tap. Fred Bornman, W8QDU, says that he is able to use 15 turns of no. 14 wire wound on a one-half inch inside diameter, in a 1¼ inch length—using acorn tubes, to be sure, but apparently not tapped down. Such a coil is a target to shoot at, though standard tubes naturally will load the circuit more.

Some television receivers are using the 1852 (or 1851) as a mixer in superheterodynes. This is an idea that may be well worth our consideration. To be sure, the r.f. amplifier should determine the signal-to-noise ratio of the set and, therefore, the level of the weakest signal to which the receiver will respond—if there is no horribly inefficient stage following—but improved conversion efficiency will usually be welcome.

Olla Podrida

Last month we promised to give you another word meaning *potpourri*. It is *olla podrida*. Quick, Jeeves, the dictionary!

We have heard a lot of fellows asking for more c.w. on the band, especially to help in identifying weak dx, and many objections to having to stabilize. Yet the simplest answer to the new regulations seems to be to disconnect the modulator and key the oscillator. It's legal, but this i.c.w. used by crystal controlled stations does not appear to be.

Juan Lobo y Lobo, XE2N-XE1A, writes saying that he is willing to put his transmitter on five meters and undertake tests with anyone who will lend him a tested and calibrated 56 Mc. receiver (or converter). With no stations available to mark the band or test a receiver, he doesn't want to start from scratch. Mexico City should be a good point for dx work from Texas and Oklahoma on summer 1200 mile sporadic-E skip. There is but little time left to try winter F₂ skip this year, which would reach out to San Francisco, Minneapolis, Buffalo, Philadelphia and points south. The way XE1AY used to come through on ten meters suggests that higher frequencies are usable to Mexico, so the idea of getting Lobo on 56 Mc. may have some value. Kroger, former XE1AY, is in Mexico City and can help to put XE1A on "five." Does anyone want to give Lobo some help on the receiver problem?

W3BYF says that he should be added to the W.A.D. list, having contacted six districts and eleven states; he feels that we should reprint the list to encourage competition such as is done with the W.A.Z. list. This is something we intend to do before the spring dx season, so send in any additions or corrections.

Ed Doherr, W8CIR, writes that his haywire Yagi couldn't resist taking off during a recent blow, and trying to cross-wind three point landing in the yard. A new structure is soon to go up. The old one was fine while it lasted, and was well worth an afternoon's work!

W8QKI, in Ashtabula, Ohio, now puts 300 watts into 35T's and has a new beam. It uses four phased elements, H-type, together with a close-spaced reflector and director on each element, a total of twelve elements. He expects a 12 db gain, but has not given it a real test. So far, he can work W8VO in Akron, W8GU and W8NBV in Erie. Last summer on 100 watts and an 8JK antenna, he worked W8QDU in Detroit, which he expects to better with the new set-up.

In the middle of Pennsylvania, W8OKC has been able to push out over the mountains with 300 watts. His antenna is a twenty meter center fed vertical, so a new five meter job may give him still better results. There are a lot of five meter stations in the valleys of his state; coöperation may bring about some nice dx.

In Bridgeport, W1BRL has brought out his "bug" to do some c.w. work now that the band has gone "stable." W5CSU/1 at M.I.T. in Cambridge, Mass., is on 56.55 Mc. with c.w. during a phone rebuilding job. He is equipped to operate on code because more dx can be worked consistently with signals too weak for modulation. He often hears weak fading carriers and hopes that the gang will become more c.w.-conscious.

The band around Pittsburgh has been reported in a total eclipse, the only stations heard being in Youngstown, Ohio. W8VO in Akron says he will be on "five" an hour or so daily, with his half k.w.

By February, W8QDU in Detroit promises to have his new 1 k.w. final completed, his rebuilt receiver hopped-up with an acorn preselector, and a high gain antenna built to replace the vertical four-section W8JK that came down after last summer's dx.

In Kalamazoo, W8CVQ (58.02 Mc.) says that while he has been able to work W9CLH near Elgin, Illinois, he will probably work 150 miles more consistently with his new receiver. His signals reached W8MDA in Ann Arbor and W8QDU in Detroit but contacts were difficult on account of low receiver sensitivity. Also, he points out that 150 mile dx, such as working W9CLH, can often be accomplished on c.w. when phone is too weak.

W8IUD in Wyandotte, Mich., will be using W8RHF on 58.104 Mc. for the dx relay, using 60 watts, a new receiver, and a beam on the high school.

In Bartonville, Illinois (not Peoria as reported before!), W9ARN continues to use a ten meter V beam pointed at Europe. He has worked W9CLH at Elgin and W9ZHB at Zearing recently, but he seems to be weak on receiving. This may be corrected soon with some sort of an array.

In Kansas City, W9ZJB has a new 5-10 receiver. To give it a test on ground-wave dx,

he took it to W9UIZ at Leavenworth (30 miles), hooking it to a Reinartz beam. He could hear W9SMM in Kansas City but no other. At noon, W9ZD and W9AHZ were heard but they could not be located earlier although they were on the air. W9SMM dropped in strength when the other stations were coming in; he is located on the 14th floor of a hotel while the others are low on the ground and either using low power or are farther away. A superregen receiver could not pull in the signals. Two weeks later, with the receiver at W9ZD, W9UIZ could be brought in although he was inaudible on a 1-10 superregen. Except for a few isolated cases, 30 mile dx had been impossible out this way before the superhet was brought in, although all of these stations were in on the summer 400-1200 mile work. Receivers were again largely the trouble.

The British *Short-Wave Magazine* has learned from F. H. Pettit, SU1SG, that SU1WM and SU1RD will shortly join other Cairo operators who are making tests on 56 Mc.

We have considered publishing the calls of active 56 Mc. stations in each state, or showing maps, to increase the knowledge of each operator about his neighbors and to encourage attempts to bridge the gaps. This will involve using calls reported in the dx last summer, or hearing from a large number of stations with advice as to who is known to be on five meters. What do you say about this, gang?

On To 2½!

For local rag chewing and mobile work, 2.5 meters is virtually as effective as 5 meters, with the advantage that much simpler and less expensive equipment can be used. The only valid excuse amateurs have for neglecting this band for this type of work is that "there's nobody down there to work." That in itself is a good reason for going on 2.5 meters, rather than an excuse for avoiding the band.

It is merely a matter of getting the ball rolling. Simple, effective, and inexpensive gear for 2.5-meter operation will be described shortly in RADIO. To assist in getting some pioneers going on the band, we will publish calls and locations of active 2.5-meter stations until such time as the band is sufficiently inhabited that activity carries along under its own momentum. This will enable 2.5-meter enthusiasts to make schedules with others in the same vicinity. If you expect to have a rig on 2.5 meters in the near future, drop a card to the Associate Editor of RADIO, 512 No. Main St., Wheaton, Ill., giving your call and location.

112 Megacycles

By E. H. CONKLIN*

Milwaukee

Our first letter on the subject, since the new regulations on "five" rejuvenated the 2½-meter band, is from W9ZGD. He says that 56 Mc. in Milwaukee is getting more dead every day, while 112 Mc. has been perking up. Of the old five-meter gang, half are stabilizing and the other half are pruning their wavelength. So far, he has worked only five stations, having heard nine—including three harmonics, and being reported by ten; best dx heard so far is W9LQR's harmonic at eight miles, though he was heard by W9JPU at Cedarburg, fourteen miles away.

Receivers in Milwaukee are all superregenerative, ZGD using a 76 detector and 6C5 quench oscillator; the transmitter has a pair of 45's at present, working into a simple antenna. W9ANA and W9YYY are also looking for out-of-town dx.

Wouldn't it be funny if the 2½-meter boys work between Milwaukee and Chicago before the five-meter gang does?

Chicago

With the five-meter band nearly dead—there were only a few stabilized transmitters before December first—several of the Chicago stations have gone to 112 megacycles. One group includes W9SFW-LRT-LRM-FFG. These stations used a Lecher-wire system to find the band, checking it with crystal harmonics. Another group includes W9ZEO who is only receiving, W9YSV who has a transmitter but is rebuilding his receiver, and a few others. These used harmonics of a 28-megacycle crystal to find the band but seem to have a separate one from the first group. Others reported active are W9MQM-MXK-AAU-TXJ. Joe Hanley, W9YSV, is surprised at the signal strengths reported, which seem fully as good as on 56 Mc. So far, modulated oscillators and superregenerative receivers predominate.

Jim Dickert, W9PEI, the noise-silencer man, used to talk to himself on 116 Mc. in Chicago a few years ago. He put an a.c. modulated oscillator on top of the Chicago Daily News building and asked club members to listen to it but received only one report. His car receiver could pick up the oscillator at Highland Park, some 23 miles north, and nearly to Elgin, 35 miles west,

[Continued on Page 80]

* Associate Editor, RADIO, 512 N. Main Street, Wheaton, Illinois.

NEW BOOKS

and trade literature

THE AMATEUR RADIO HANDBOOK, first edition. Published by the Incorporated Radio Society of Great Britain, 53, Victoria Street, London, S.W. 1. 300 pages, 6½" by 9½", price 2/6 in Great Britain, 3/6 overseas, postpaid.

For years the British radio amateur was dependent almost entirely upon American publications for detailed technical information on the more generalized aspects of amateur radio. In 1933 the *Guide to Amateur Radio* was published and received such widespread acceptance during the first five years of its publication that it was decided this year to publish a complete British Amateur Radio Handbook. This book is the very worth-while result of that decision.

The work is well and completely written from start to finish. It is similar in scope to the two well-known American publications in the field in regard to fundamentals, receivers, transmitters, antennas, and operating procedure, but is written from the point of view of the British amateur and the construction data applies mostly to British made radio gear. The material given in the subject matter for each chapter has been written by authorities in that field and hence, is very well based. One complete chapter is devoted to television, from fundamentals to present systems; for the American amateur interested in this field of experimentation, this chapter alone makes the book well worth the price. Another chapter is devoted to the calculation of great-circle distances by means of spherical trigonometry; this section should be of interest to the dx man who lives some distance from a point where there is a great-circle map available. Taken altogether, the book would make a valuable addition to the reference libraries of American amateurs, and is indispensable to British amateurs.

An equipment catalog produced especially for radio servicemen and sound equipment men was issued this week by Sears, Roebuck and Co. The new catalog, which comprises 44 pages 8½ by 11 inches in size, is being distributed through the company's headquarters in Chicago. Orders for items carried in the book will be handled at all of Sears 10 mail order plants and several hundred retail stores.

THE RADIO MANUAL, by George E. Sterling. Third edition, published by D. Van Nostrand Company, Inc., 250 Fourth Avenue, New York, N. Y. 1120 pages, 5" by 7", price \$6.00.

This, the third edition of the Radio Manual, has been prepared to serve as a guide and textbook for those entering the radio profession as engineers, inspectors, or operators as well as those already engaged in such activity. The book has been written primarily from the practical viewpoint to serve better the needs of those who are engaged in the installation and operation of radio equipment for the various services. The entire scope of the field is covered from the introductory chapter on electricity and magnetism through the chapters on batteries, motors and generators, and the fundamentals of the electron tube, to the chapters on more advanced subjects such as oscillators, amplifiers and modulation systems.

In addition to the sections mentioned above and the chapters on operating technique of the various services, the book covers the most recent advances in every branch of radio. Among the material on very recent subjects will be found the new Cairo Revisions of the General Radio Regulations (effective Jan. 1, 1939); a complete course in air navigation using the latest aids; the two auto-alarms approved by the FCC; the latest transmitting and receiving equipment for marine and aviation use; all the newest developments in broadcasting—transmitters, modulation systems, modulation and frequency monitors, methods for determining distortion and frequency characteristics, volume indicators and recording systems. In addition, all the U. S. Government Regulations are given, and a specimen examination for operators seeking employment in commercial ground and aeronautical stations is shown.

Each of the major fields of commercial radio communication—broadcasting, aviation radio, marine radio, police radio, and point to point—is exhaustively covered. The work would be an invaluable addition to the libraries of amateurs and other persons who are engaged in, or are desirous of becoming engaged in the above fields of commercial radio.

[Continued on Page 86]



Seattle, Warsh.

Dear Hon. ed.

I wish you would writing pleez one of the toob advertisers for me and telling same where to get offs at. They are a bunch of bums, shyster, louses, and besides are not knowing the first thing about toobs and also are not gentleman. Scratchi are have so much indignation he are ready to spit.

When I send in a defective toob for replacement along with literary masterpeece claiming toob was unsatisfactory on account of it head in direction of setting sun after only few hours use at half of rated inputs, what you think those chisler do? They write a nasty letter to general effect that after examining toob they were amaze that I have effrontries to expeck adjustment.

Of course, Hon. ed, I realize that toob are look sort of sad and appear as though are have suffer 5000 volts at various amps. But that are because toob must be no good, and I explane to those bums that reason I not send in toob until 6 years after making purchase of same is that I bot toob for a spare and are not take out of seeled box until short time ago.

Imagine, Hon. ed., those impolite snake impunging honorable integreties of honest fellow like Scratchi by expressing suspicion that toob have been in 24 hour service ever since I bot it 6 yrs. ago because same are apeering to them like latest roses of last summer after being drawed through a not hole.

Scratchi are resent such dirty cracks and are not buying toobs just to be insulted, and I hope that you will notify pleez this gyp advertiser that if he are going to manufacture inferior product and advertise same that he must be willing to stand behind same and make replacements insted of accuse customers of being champeen,lyer on purely circumstanshal evidence, such as melting of sodder that holds on the grid cap on the top of the toob. This were done by accidental

contack against soddering iron and not from heeting of toob envelope as you might think.

Respectively yours,
HASHAFISTI SCRATCHI

P.S.: Will you pleez telling me Hon. ed. whether the toob base diagrams for socket connections as given in your handbook means the bottom view when looking up at the socket or the bottom view when looking down on the socket.

The Open Forum

WHERE TO LISTEN

Hugo, Okla.

Sirs:

About a year ago I wrote you deploring the fact that dx stations never listened on the high frequency end of the 10-meter band, and that very few W stations did either.

Things are just about as bad now, except that on week ends it is now possible to work a few W stations without too much trouble. The dx stations still refuse to listen above 29,000 kc. You would think these dx stations would encourage occupancy of the high frequency end by W stations, in order to reduce QRM on the low end and permit their own signals to get into the states without several coats of QRM plastered over them. But no, they just work the stations on the low end, which results in everybody piling up just above 28,500 kc. and covering up a good portion of the dx.

The fellows who were good sports and bought crystals and moved to the high end to reduce QRM should plunk themselves right back on the low end and show the dx stations that if the gallant gesture wasn't appreciated and if no cooperation is forthcoming there is no point in staying down there and leaving all the dx to those too selfish to spread out and untangle the pile a bit.

Well, here's hoping that some of the choice 10-meter dx stations made a New Year's resolution to tune from the 30-Mc. edge of the band occasionally.

Ed Harris, W5TW

[Continued on Page 87]

RADIO

PUSH-BUTTON CONTROL

[Continued from Page 37]

Installation

The push buttons are mounted together on the operating desk and the three connecting wires can be almost any convenient length within reason (a 500-foot line was used in one remote-control installation). The control wires carry only a small amount of d.c. as contrasted to a comparatively large amount of a.c. as used in the majority of remote-control systems. It may be noted that push button no. 2 appears at first to be backwards. To turn the transmitter on, a circuit normally closed is momentarily opened, then the spring of relay A keeps the original circuit open and holds the transmitter power control relay closed. This button was made from a standard doorbell push button with the contacts and spring action reversed to keep the contacts closed until the button is pressed.

Note again the safety switch in series with the high-voltage transformer primary. This switch must first be opened when the transmitter is to be closed down and should not be closed again the next time the rig is to be operated until after the filament voltage and bias packs have been turned on and the control circuit has been reset. It also must be opened, for safety's sake, when any adjustments or coil changes are to be made upon the transmitter. These precautions will prevent the accidental application of the plate voltage by inadvertent disconnection of the holding relay circuit. An additional safety switch, in series with the one shown, could well be of the type that is fastened to the inside of the transmitter door cover to open the circuit when the door is opened.

SCREEN VOLTAGE ON 6L6'S

[Continued from Page 41]

the amplifier is either loaded or run off resonance.

Incidentally, more screen voltage may be safely applied when the tank circuit is working into a load, as the screen current will then be less and the screen dissipation less. Have you noticed how the plate current to a 6L6 or 807 or T21 will gradually creep up when the load is removed (assuming maximum rated screen and plate voltage). This is due to the heating of the screen, which gets quite warm when the plate current is low and there are lots of electrons available for screen current. This effect will be less noticeable when a screen dropping resistor is used to obtain

A New Type of Push Button Switch

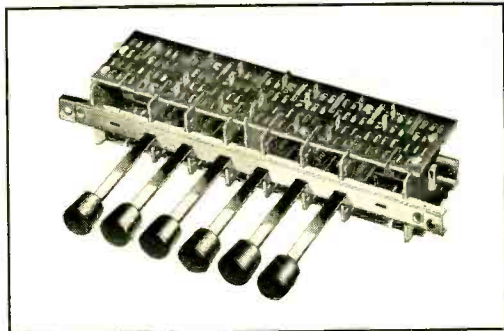

for Meter Switching on Test Equipment, Analyzers, Tube Checkers and Radio Transmitters

The Mallory-Yaxley Type 2190 non-shorting switches provide new convenience, simplicity and economy in the construction and operation of radio test equipment. Through it a single current reading meter may be used to measure a number of circuits... the insertion of the meter in the circuit being accomplished merely by depressing a button. Other circuits connected to the switch remain closed and uninterrupted. Mallory-Yaxley Type 2190 switches are also suitable for meter switching on low and medium power radio transmitters, and public address systems where they replace with added safety, conventional jack and plug systems.

P. R. MALLORY & CO., Inc.

INDIANAPOLIS

INDIANA

Cable Address—PELMALLO

Use

MALLORY
APPROVED RADIO
PRECISION PRODUCTS

Use

YAXLEY
APPROVED RADIO
PRECISION PRODUCTS

screen voltage, as the increased screen current will result in lower screen voltage, thus tending to limit the screen dissipation.

Because the actual screen dissipation depends upon so many factors, perhaps the best rule to follow is to watch the screen and make sure that it doesn't show color. If it runs red the screen voltage must be reduced. To those who want to know how to see the screen in a 6L6, we suggest the use of 6L6-G's.

REMOTE CONTROL SWITCHING

[Continued from Page 44]

Home Station Control Receiver

The control receiver as used by the author was a simple three-tube (not including VT₂) superhet; one 6A8 first detector-oscillator-mixer, one 6K7 i.f. stage and a 6H6 second detector. This particular receiver was run on the 110-volt a.c. line rectified by a 25Z5, thus eliminating the use of a power transformer. This receiver is nothing special except that the plates and cathodes of the 6H6 are paral-

leled, making a very active circuit. Instead of a superhet a simpler one- or two-tube regenerative set could be used. However, the t.r.f. circuit, due to lack of sufficient selectivity and sensitivity, will lay the system open to the blanketing effect of local signals operating near the frequency which the remote control uses. Also the strong r.f. field of the home station transmitter may be difficult to keep out of the receiver. At the home station it goes without saying that the control receiver antenna should be well isolated from the field of the transmitter.

I know many readers have wondered by this time how the home station control receiver is to be turned on when operation of the system is desired. This should present no problem because when the operator leaves home for the remote point he can turn on the receiver and it can be warming up and becoming stable while he is en route. If regular periods of operation are contemplated, one of the many timing devices can be used to control the receiver. In this case it is possible to have a point on the selector which will turn the receiver off once the timer is on.

Needless to say, there should be some provision at the remote location for monitoring the signal of the home transmitter. After you have the system working properly some interlock arrangement may be desirable to prevent accidentally having two antennas or two crystals connected in at the same time. Many ideas should present themselves to the builder and he can change various parts to suit his own needs. Variations of this "wireless" control system are practically unlimited. The purpose of this description as used by the writer is to give the constructor ideas with which to work. In a few months the cost of the system will be cancelled by the increased flexibility of modern break-in as measured against telephone company leased-wire costs for a "wired" control system.

See Buyer's Guide for parts list.

REVIVING 80- AND 160-M. DX

[Continued from Page 47]

and the simple end-fire array where it is limited. One-tenth wavelength spacing of two or three short grounded verticals, with power actually fed to only one, should be possible. A one-half section W8JK using vertical grounded elements will give gain, directivity, and increased low-angle radiation.

On the higher frequencies, even 7 Mc., placing a duplicate antenna system below the



WIRELESS PRACTICE SETS

R-68 PRACTICE SET

Designed for those who want a well made instrument to learn the code. Set consists of a key and high frequency buzzer mounted on a mahogany finished wood base equipped with binding posts. The code is printed on a plate and fastened to the base between the key and buzzer. Buzzer is adjustable. List \$3.40.

SIGNAL's line of Wireless Keys, Telegraph Instruments and Wireless Practice Sets is complete. Send for our bulletin.

SIGNAL ELECTRIC MFG. CO.
Menominee, Michigan, U.S.A.

SIGNAL
MANUFACTURERS OF ELECTRICAL PRODUCTS

RADIO

present one* (if there is sufficient space below the old antenna to avoid substantial ground losses which might result from having the lower section too close to the ground) and feeding it in phase, is one possibility, although more commonly some other type of beam is used with similar results. Low-angle radiation normally results from using the flat-top beam, the end-fire array, long-wire arrays, or parasitically excited elements as in the Yagi or the three-element beam.

Equations

The angle of elevation (vertical angle above the horizon) for a given layer height and distance is obtained by using these equations with the notation of figure 1:

$$\sin X = \frac{r \sin (V + 90^\circ)}{r + h} = \frac{r \cos V}{r + h}$$

$$V + X + D = 90^\circ$$

* E. H. Conklin, "Antenna Gain without Horizontal Directivity," RADIO, May, 1937.

250-WATT TRANSMITTER

[Continued from Page 53]

Although a certain amount of care and ingenuity is necessary throughout to build and line up the transmitter, its clean-cut operation and remarkable efficiency on frequencies that only a few years back were considered almost unmanageable will more than repay the builder for a certain amount of painstaking work.

Coil Winding Data

56 Mc.

Oscillator—6L6 (shell grounded) 7 Mc. 22 turns of no. 22 enam. 1½" diam. 1½" long. Plate tapped on 11th turn.

1st 807—9 turns no. 12 wound ⅞" diam. and 2" long.

2-807's—1 turn no. 12 wound 1⅜" diam. Link 2 turns 1⅜" diam.

Final Grid Coil—7 turns no. 12 wound ⅞" diam. and 1¾" long. Link coil 3 turns ¾" diam. no. 18 pushback.

Plate HF-100's—6 turns no. 12 wound ⅞" diam. Each section 9/16" long. ¾" between coils.

Ant. Coils—3 turns no. 12 tin copper ⅞" diam. ½" long.

[Concluded on Next Page]



IT'S "PIE" FOR CENTRALAB

If we were to show the replacement business of the serviceman as a pie, the failure of the average Fixed Resistor would account for a slice that is more than a quarter of the whole pie. That means, of course, that Old Man Centralab plays an important part in the replacement business.

And with a resistor, hard-as-stone, impervious to moisture, shocks, excessive temperatures, and vibration, the wise service man finds it "easy as eatin' pie" to completely satisfy that resistor need with CENTRALAB.

Always specify, nay, insist on Centralab.

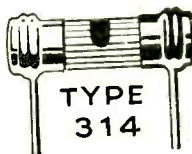

TYPE
314

Baptized in fire at 2500 degrees . . . hard as stone. Center core and ceramic jacket fired together to form a single shock-proof unit. Pure copper covers resistor end for wire lead contact.

Centralab

Division of Globe Union, Inc.
MILWAUKEE, WIS.

British Centralab, Ltd.
Canterbury Rd., Kilburn
London N.W.6, England

French Centralab Co.
118 Avenue Ledru-Rollin
Paris X1, France

A 250-WATT-TRANSMITTER

28 Mc.

Oscillator—Same as for 56 Mc.

1st 807—15 turns no. 12 wound $1\frac{1}{8}$ " diam. and $2\frac{1}{8}$ " long.

2-807's—7 turns no. 12 wound $1\frac{1}{8}$ " diam. and $1\frac{1}{2}$ " long. Link 2 turns no. 18 pushback $\frac{3}{4}$ " diam. placed inside cold end of coil.

Final Grid Coil—13 turns no. 12 wound $1\frac{1}{8}$ " diam. and 2" long. Link 2 turns no. 18 pushback $\frac{3}{4}$ " diam. placed inside center of coil.

Plate HF-100's—10 turns no. 12 wound $1\frac{1}{2}$ " diam. Each 5 turn section 1" long $\frac{3}{4}$ " between sections.

Ant. Coil—4 turns no. 12 wound $1\frac{1}{2}$ " diam. and $\frac{5}{8}$ " long.

14 Mc.

Oscillator—Same as for 56 Mc.

1st 807—37 turns no. 18 d.c.c. close wound on bakelite tube 1" diam.

2-807's—16 turns no. 12 wound $1\frac{1}{8}$ " diam. $2\frac{1}{8}$ " long. Link 2 turns no. 18 pushback $\frac{3}{4}$ " diam. placed inside low end of coil.

Final Grid Coil—27 turns no. 18 d.c.c. close

wound on bakelite tube 1" diam. Link 2 turns no. 18 pushback wound over coil at center.

Plate HF-100's—12 turns no. 10 wound $2\frac{3}{8}$ " diam. Each 6 turn section 1" long, $\frac{3}{4}$ " between sections. A few coats of clear Duco cement across top center of coil will make this coil very rigid.

Ant. Coil—3 turns no. 10 wound $2\frac{3}{8}$ " diam. and $\frac{3}{8}$ " long. Apply Duco cement same as on plate coil.

See Buyer's Guide for parts list.

FLASHER-TYPE MODULATION INDICATOR

[Continued from Page 58]

It is well to remember that overmodulation on *negative* peaks is the chief cause of side-band splatter. Consequently it may be best to monitor *negative* peaks continuously and to use the positive peak indications only to balance positive and negative peaks when making adjustments on the transmitter. For most satisfactory operation it is best to set the percentage indicator so that the lamp will just flash when a peak of 90 to 95 per cent modulation comes along. This will allow a factor of safety to give an indication of the sudden peaks that may be more than five or ten per cent higher than average level.

Almost any type of mechanical construction may be employed when building the monitor. A 6-inch square chassis with a small panel for the instrument and the controls makes a convenient size. R_1 should be mounted so that it cannot accidentally be moved as a change in the setting of this potentiometer will destroy the calibration of the unit. It should preferably be mounted on the back of the chassis with a slot in its shaft for screwdriver adjustment.

See Buyer's Guide for parts list.

TAKING TEN FOR A RIDE

[Continued from Page 56]

placed on the dash board. With the microphone strapped about the neck, operation is very simple and both hands are free to operate the car in its proper manner.

The author has enjoyed many dx contacts with this rig. Every morning on the way to work many eastern stations are worked with splendid reports. Several Australian contacts have been made, and the Hawaiian Islands are worked very easily. Being able to contact sta-

at it again!
that "Houdini" among Hams
FRANK LESTER
QRX for sensational new development
in amateur radio



OF INTEREST TO EVERY HAM! WATCH FOR SPECIAL ANNOUNCEMENT IN NEXT ISSUE!

NO NEED TO WAIT for this new **FREE** catalog. It's 1939's guide to *what's what* in amateur radio. Every page talks value, every item at a saving. And there are thousands of items—all unconditionally guaranteed. Don't be without the world's finest radio catalog. **Mail coupon now!**

WHOLESALE RADIO SERVICE CO. INC.
 NEW YORK, N.Y. • CHICAGO, ILL. • ATLANTA, GA.
 100 SIXTH AVENUE 901 W. JACKSON BLDG. 265 PEACHTREE STREET
 BOSTON, MASS. • BRONX, N.Y. • NEWARK, N.J. • JAMAICA, L.I.

WHOLESALE RADIO SERVICE CO., Inc.
 Dept. 6B9—100 Sixth Avenue • New York, N. Y.
 Rush **FREE** Radio Catalog No. 73

SAVE DOLLARS SEND THIS COUPON NOW!

Name..... PLEASE PRINT
 Address.....
 City..... State.....

PASTE COUPON ON PENNY POSTCARD

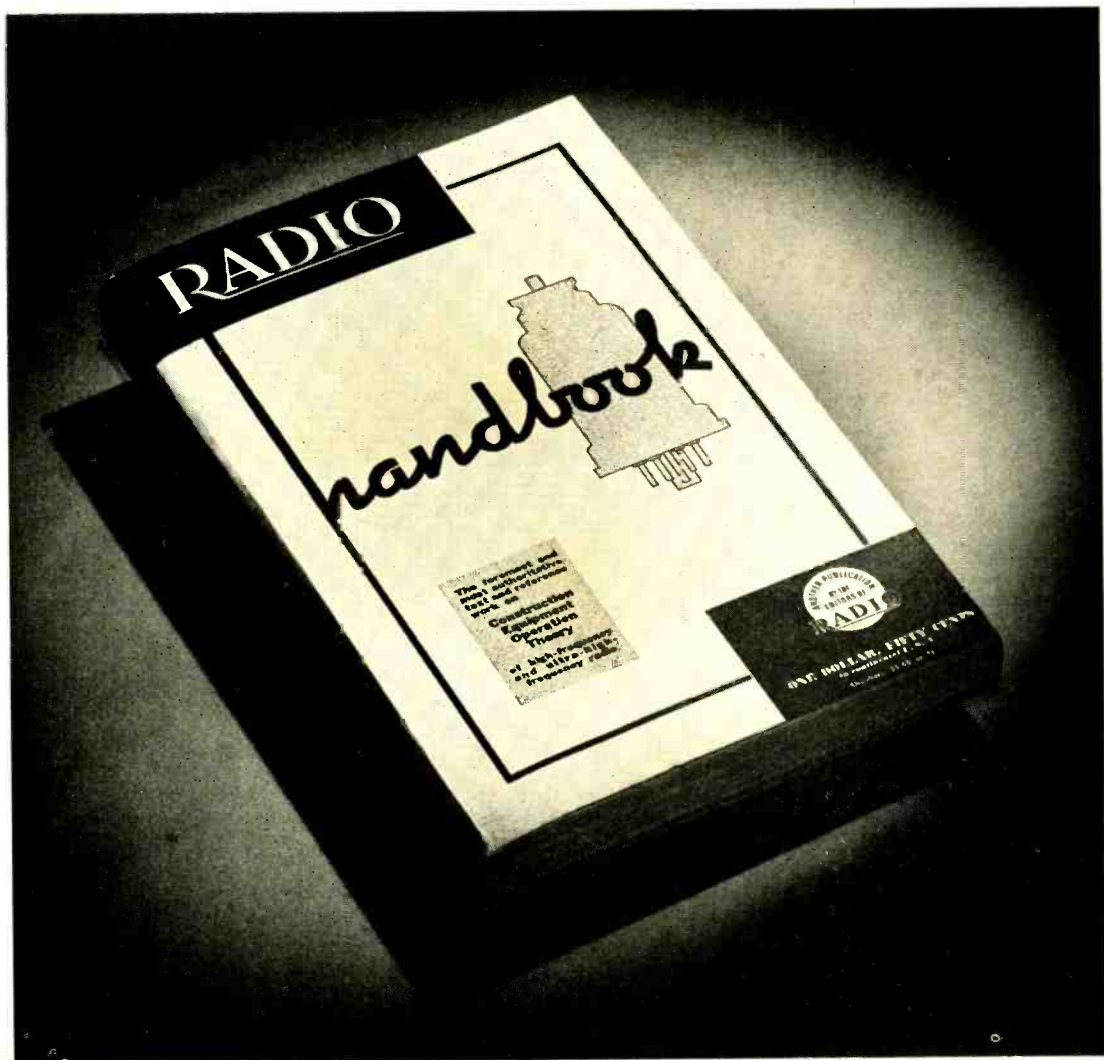

ORDER YOUR COPY . . . TODAY!

The new, 1939 "RADIO HANDBOOK" with over 550 pages, profusely illustrated, is the foremost and most authoritative text and reference work on Construction . . . Equipment . . . Operation . . . Theory of high- and ultra-high frequency radio obtainable. Get it from your local radio parts dealer, or order direct from us.

ONE DOLLAR, FIFTY CENTS

In Continental U. S. A.

\$1.65 Elsewhere

RADIO
LIMITED

Technical Publishers

7460 Beverly Boulevard, Los Angeles

COIL TABLE
(29 Mc.)

- L₁—26 turns no. 14 enameled wound on 1¼" dia. and strengthened with ribs of Duco cement
- L₂—15 turns no. 14 enameled wound on 1¼" dia.
- L₃—7 turns no. 14 enameled wound on 1¼" dia.
- Antenna link—2 turns 1¼" dia., insulated wire

tions several thousand miles away while driving along is quite a thrill, especially with low power.

The entire transmitter including all parts, tubes, etc., can be built for approximately \$50. This includes the two vibrator packs, which are the biggest item both physically and financially.

See Buyer's Guide, page 98, for parts list.

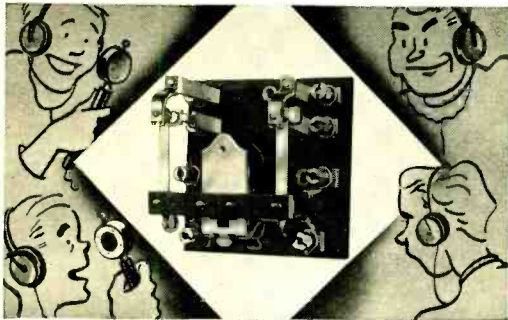

Antenna Changeover Relays

You need one of these relays to change automatically from sending to receiving. You will find these relays described in circular 507B. Send for a copy.

WARD LEONARD

PROTECTIVE MAGNETIC RELAYS

WARD LEONARD ELECTRIC COMPANY
29 South St., Mount Vernon, N. Y.
Please send FREE Bulletin 507B.

Name

Street

City and State

Call Signal

112 Mc.

[Continued from Page 72]

with strength comparable with 56 Mc. He has promises of activity from a half dozen members of the Illinois Ham Club and intends to get back on the air.

Dickert uses a resistance-capacity coupled super-heterodyne. After working on the receiver for awhile, the sensitivity rose to the point where auto ignition was louder than on five meters. He promised to bring this receiver out to Wheaton for comparison with the concentric-line tuned circuit acorn t.r.f. jobs we described in RADIO for January, 1938 and 1939.

Equipment

Really good equipment is not hard to build at this frequency. Concentric lines for use as tuned circuits are effective when only a foot long, tuned with screw-type two plate condensers. Admittedly, acorn tubes are a substantial advantage if 100- or 200-mile dx is to be attempted. Here again as on five meters, narrow i.f. channels and stabilized transmitters will give better signal-to-noise ratio and better dx. A converter to go ahead of a communications-type receiver should be entirely satisfactory for receiving stabilized signals if the converter has enough r.f. and conversion gain to avoid a loud hissing noise on normal signals which, as a rule, means limited sensitivity.

In addition to long-wire antennas such as the V and rhombic which are of back-yard size, portable Yagi arrays are simple. A horizontal 2 x 2 can be drilled to support the centers of half-wave elements to form a Yagi having good gain.

According to the RCA article in *I.R.E. Proceedings* for November, 1938, horizontal polarization was selected for their New York-Philadelphia 100-Mc. circuit, the transmission path being entirely over land in which case there is apparently no advantage in vertical polarization (see the paper by Trevor and Carter in *I.R.E. Proceedings*, March, 1933).

DX

W9YYY says that he heard a 120-Mc. harmonic of a California commercial while 56 Mc. was open one day in 1937. We don't know of any day that year when 56 Mc. was open from Milwaukee to California, though at times on June

CORRECTION

On page 509 of the 1939 RADIO Handbook, the caption of the cut in the Crowe Name Plate & Mfg. Company advertisement should read: This precision tuner is only one of the many new items illustrated in Bulletin 225 and sold by your jobber.

One of a kind!

The "NEW" RADIO ANTENNA HANDBOOK is the first—foremost—and ONLY book written exclusively on the subject of Antennas. Containing everything that is worth telling about this important subject, it is invaluable to you regardless of what books you already possess.

Profusely illustrated, the new book features many diagrams, tables of dimensions for all frequencies (no calculations necessary), dope on all practical arrays and directive antennas, and feeders of all types. In addition, several practical multi-band antennas are fully described.

Be sure to order your copy—Today!

Seventy-five cents

(In Continental U. S. A. Elsewhere 85c or 3s 6d)

RADIO Limited

Technical Publishers
7460 Beverly Boulevard
Los Angeles

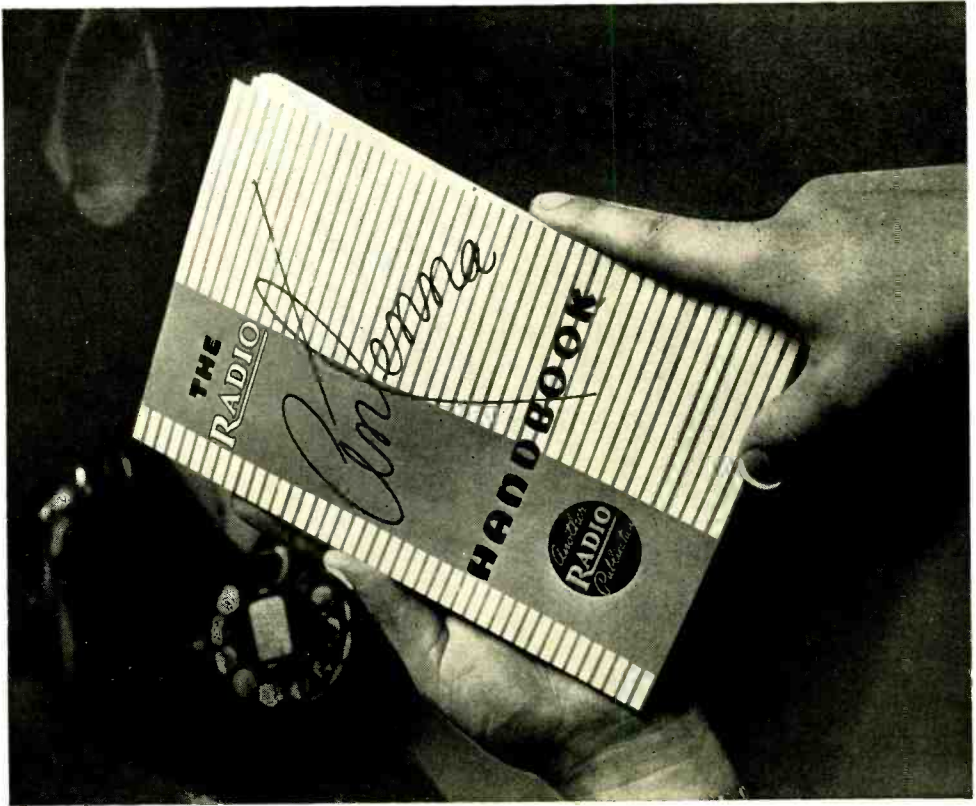

5, 1938, the E layer was good enough for 1200-mile skip on 112 Mc., according to our calculations. One way to hear good dx on 2½ meters is to have somebody nearby listen with a radiating regenerative receiver to a lower frequency fundamental of a dx station, reradiating harmonics. This accounted for some remarkable dx on galena crystal receivers in the old days.

A letter from W1EFN advises that the Albany, N. Y., five-meter gang is reported to have moved to 2½ en masse. The Albany fellows, however, promise to be on 56 Mc. for the relays.

Stations in the east used to get some good dx on 112 and even on 224 Mc. With the heavy 56-Mc. population and the probable drift of unstabilized rigs to 112 Mc., there should be a lot of activity. Let's have some letters from the active stations so that everyone can learn who is on the band within a 100-mile radius, thus making co-operation possible.



THE law requires that every amateur station shall regularly check and measure transmitter frequency. Frequency measuring apparatus is required to be external to transmitter frequency control. For precise frequency measurement a stable and dependable frequency meter/monitor is indicated. GUTHMAN is proud to offer the precision frequency meter and amplified monitor illustrated above, and parts for its construction.

This instrument provides features heretofore available only in precision laboratory equipment. Designed for precise measurement, it offers 7¾", 324 degree dial accurately calibrated for 5 to 160 meter bands, zero adjuster for use with 22 precision calibration frequencies regularly available, A.C. or D.C. operation, voltage and temperature stabilization of electron coupled oscillator, and monitor amplifier.

It is styled to "dress up" any station, priced extraordinarily low, designed for precision work. See your jobber, or write for full details on this and an outstanding line of quality r.f. and i.f. transformers, fixed and variable condensers and other parts.

EDWIN I. Guthman & CO., INC.
402 S. PEORIA ST. • CHICAGO, U. S. A.

PULSING AMATEUR TRANSMITTERS

[Continued from Page 34]

about 50 microseconds. If longer pulses are desired the pulser capacitance may be increased from the 0.01 μ fd. (two 0.005 μ fd. in parallel) value to perhaps 0.03 μ fd. with a corresponding decrease in the value of the resistors in the network. The 50,000-ohm grid resistor should not be decreased in value since its function is to prevent any abnormal flow of grid current. For the type KU-627 the 15-volt a.c. and 34.5-volt d.c. grid potentials seem to be fairly critical if maximum pulse voltage is to be obtained. Figure 16 is a photograph of a good output pulse superimposed on a 60-cycle sweep of a cathode-ray oscilloscope.

Pulsers could be described from now until the last CQ has been sent and still variations could be devised to make new circuits. This group of devices should provide plenty of material for several months' experimentation, when we shall perhaps have some new and better circuits ready for description. The multivibrator circuits, 885 tubes in low power pulsers with video type modulators and the use of the KY-21 mercury-vapor tube present enough various possibilities for thought along that line.

At an early date we shall present the subject of receiver correction for pulse reception, the calibration of oscilloscope sweep rates, and a treatment of the actual results obtained in the practice of ionosphere sounding experiments.

See Buyer's Guide, page 97, for parts list.

BEAM POWER AMPLIFIER

[Continued from Page 22]

Special Features

This a.c.-d.c. amplifier has a surprising amount of reserve gain. It accommodates either a crystal microphone or a velocity microphone of the type that feeds directly into the grid circuit of the first tube. Both types of microphone may be used interchangeably without preamplification. The writer found that he could talk at normal voice level five feet from a velocity microphone, with the gain control one-quarter open, and bang the needle of an output meter reading 8 watts maximum.

[Continued on Page 85]

RADIO

DX

[Continued from Page 66]

and this to the astonishment of the neighbors. We do not know our new neighbors yet . . . but we will, shortly after the key is punched for the first time. Anyway, all is not gloom because I know this location will be better, in some directions, and I'm looking forward to working more W9's.

YARN OF THE MONTH

[Continued from Page 67]

never laid eyes on. Dorothy had left him, leaving a brief note to the effect that she hadn't run off with anyone, hadn't even gone home to Mama. But she'd had her fill of radio, and that was that.

Joe was desolated, as they say. He knew she loved him, and he loved her, and how was he going to find her and make her come home? I told him he was nuts and had been asking for it, but Sue, woman-like, was immediately all sympathy. They went into a huddle, crying on each other's shoulders while I stood around and cussed Joe for the fool that he'd been.

He was meek and submissive and willing to do anything if only Dorothy would come back to him. Sue gave him a lecture on how no woman would put up with what Dorothy had, and if he ever expected to see her again he'd better change his ways. Finally he went home, after we'd promised to do everything

Television ENGINEERING

The Newton Graduate Course in Television Engineering—a home study program designed specifically for Radio Engineers—provides formal study of basic principles and current practice. Scientific approach and treatment ensures sound foundation for television development and design. Prerequisite: B.S. in E.E., or equivalent. Address, Graduate Division,

NEWTON INSTITUTE OF APPLIED SCIENCE
2021-W Raymond-Commerce Bldg., Newark, New Jersey

Changes of Address

To become effective with
The Next Issue
must be RECEIVED at Los Angeles
by the 10th of this month.

Circulation Department,
RADIO

At Your
Request



A 40 METER VARIABLE

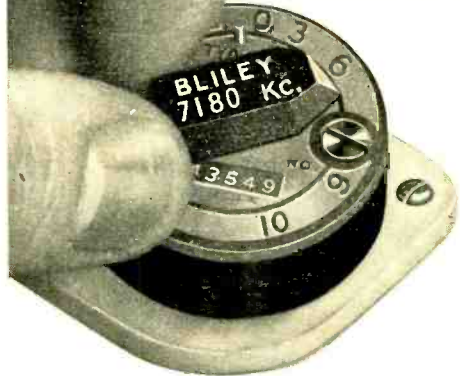

CRYSTAL UNIT

Replies received from a questionnaire sent to representative amateurs were nearly unanimous on one point . . . "We need a 40-meter variable frequency crystal!" Development work, then in progress, was speeded to meet this demand. The result . . . the Bliley Type VFI Unit for the 40-meter band.

Now, with a minimum of equipment, you can enjoy variable frequency at the higher frequency bands and still retain the stability of crystal control. The crystal frequency is variable over a range of up to 12kc. at the 40-meter fundamental, 24kc. when doubling to 20 meters or 48kc. when quadrupling to 10 meters.

The specially ground crystal has a drift of less than 4 cycles/mc./°C. It has, because of the variable frequency feature, somewhat less activity than the fixed-frequency B5 40-meter unit. However, in practically all transmitters where adequate excitation exists to the following stage, the slightly decreased power output from the oscillator requires no consideration.

Make the most of your transmitter . . . use variable frequency crystal control and operate on clear channels.

Type VFI 40-meter unit, within ± 15 kc. of specified minimum frequency . . . at all Bliley distributors . . . \$7.50.

BLILEY ELECTRIC COMPANY

UNION STATION BUILDING

ERIE, PA.

we could to help him locate the gal, plead his cause, his reformed nature, and the sincerity of his affection.

While we tore a couple of sheets off the kitchen calendar, Joe lived in solitary misery. Every so often we'd stop in to see him and compare our findings, which added up to zero. Now it was Joe who sat in the chair in the living room, only instead of reading he'd just be trying to stare down the wall paper. Once I couldn't resist the temptation to ask him sarcastically why he didn't use all the time he had to run the rig, but such an expression of pain swept over his face that I wished I'd kept my trap shut. He just said he didn't have the heart to do anything without Dorothy.

Joe lost a lot of weight and went to and from work as down-trodden and hollow-eyed as a Volga boatman. He probably ate three shades of nothing, as he was doing his own cooking, and he didn't even have enough spirit to try drinking himself to death. I guess he was just waiting for nature to take its course.

Another month had rolled over the horizon when Sue got a letter from Dorothy, apologizing for leaving without any word to her "only friends," and hoping we'd forgive and come see her some time. She was in a nearby city, working, and well and happy, thanks. Sue promptly wrote her about Joe and passed the letter on to him.

When Joe saw the letter he folded up in his big chair and started to bawl, pawing it and trying to read through his tears, while I stood around like a sixth finger and wished I was somewhere else. Watching a man cry always snarls my whiskers. Then Sue started blubbering and we all had a hell of a time.

Finally it dawned on Joe that he knew where Dorothy was and could get to her, and he tore out of the house like the Law was after him. You'd think his life depended on reaching her side in the next ten minutes. Maybe it did. Anyway, it's a cinch he beat Sue's letter.

What arguments he used in his pleading, we could only guess. But they must have been pretty potent, because when I got home from work the next night, Sue told me that Dorothy was back. She had seen her and talked with her, and there wasn't any doubt in the world that she was as much in love with Joe as ever. And now everything was going to be all right. Sue felt like a female Cupid.

We didn't stop down to see them for several nights; sort of thought we'd give them a chance to get to know each other again. I guess Sue had it figured out as a kind of a second honeymoon for them. She seems to know everything, and who am I to dispute her judgment.

Then one night Dorothy invited us over; so we prettied up as befits callers on honeymooners and hid ourselves forth in the ancestral chug-buggy.

But evidently Dorothy didn't consider it as any auspicious occasion, for when I tweaked the doorbell she merely called her cheerful, "Come in."

We did, and she was just walking toward us from the big chair as we entered. An opened book was lying in it, face down. I guess we both read the unbelievable at the same time, because Sue's jaw dropped open a foot, and mine wasn't so far above ground.

Sue finally recovered her speech to the extent of squeaking, "Where's Joe?" in a funny, high voice.

"Oh," Dorothy smiled innocently as she reached for our wraps, "he's working the rig. Joe! Oh, Joe! The folks are here."

I wished once more that I'd been quicker in opening the front door.

CORNELL-DUBILIER

StarHit ★ ★ ★ ★ **TYPE 4 AND 9**

OF THE MONTH



FEATURES OF TYPES 4 and 9

- 1 — India Ruby Mica Dielectric — Low power-factor; high Q; long life.
- 2 — Mica of Stepped Uniform Thickness — Provides high factor of safety.
- 3 — Specially-Treated Stack Assembly — Affords higher voltage breakdown.
- 4 — Vacuum Dried Stack Treatment — Low loss; high insulation resistance.
- 5 — Moulded in Bakelite — Minimum leakage; moisture-proof.
- 6 — Short Heavy Terminals — Insures good anchorage; mounting accuracy.
- 7 — Excellent Temperature Coefficient — Practically constant capacity at all temperatures.

For a complete listing of the entire Cornell-Dubilier line, send for Catalog No. 161. Free on Request.

Mica • Paper • Dykanol • Wet and Dry Electrolytics



CORNELL-DUBILIER
ELECTRIC CORPORATION
1017 Hamilton Boulevard, South Plainfield, New Jersey
Cable Address: "CORDU"

RADIO

BEAM POWER AMPLIFIER

[Continued from Page 82]

With the microphone on the back porch and the gain control wide open, a vegetable peddler in the next block could be heard crying out his wares.

Because the output transformer is "universal," either a 200-ohm or 500-ohm line may be used between the amplifier and modulator, or the amplifier may feed directly voice coils of five different values of impedance.

Considerable experimenting is possible without involving a change of the components or chassis work. If the owner desires, conventional operation with a separate, higher-voltage power supply is obtainable with much flexibility.

An enterprising experimenter might even incorporate inverse feedback at a few cents additional cost by making use of one of the simpler circuits described previously in RADIO.

The writer used this amplifier continuously while operating in a d.c. district, removing the burden of the speech amplifier from an already groaning rotary converter and making more a.c. watts available for the class-C and modulator stages. When later he moved to an a.c. neighborhood, no new building or revamping was necessary.

It will be noted that one side of the line is directly grounded. This means that correct polarity must be observed not only when using the amplifier on d.c., but on a.c. as well. It is necessary to insert the plug so that the grounded side of the amplifier is connected to the side of the 110-volt a.c. line that is grounded. If one of the amplifier fuses blows, or if the amplifier refuses to operate, the line plug should be reversed (and the blown fuse replaced). The plug should then be marked or keyed so that the plug can be reinserted correctly should it be removed. Do not under any circumstance fail to include fuses when constructing the amplifier. They may be of either the 3-amp. or 5-amp. size.

See Buyer's Guide, page 97, for parts list.

SUBSCRIBE NOW

and

SAVE MONEY

(See Page 94 for Details)

YOU'LL BE Q5-R9

All the time!

IF YOU PEP UP YOUR STATION WITH A
"ROTARY BEAM"

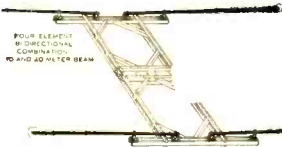

IF you want the "tops" in performance from your rig,

IF you envy the boys with those swell Q5-R9 rigs,

IF you want those hard-to-get zones,

THEN you should join the ranks of the users of GOOD Rotary Beam Antennas on 14 and 28 MC. Listen to them any day or night, Rotaries to the left, to the right, North, South, East and West, the boys who KNOW what's right are using Rotary Beams. And when you want YOURS, remember that ALLIED is Rotary Beam HEAD-QUARTERS.

PREMAX ROTARY ANTENNAS

Complete kit of Corulite tubing elements for bi-directional 14 and 28 MC beam, or unidirectional 14 MC beam. Full set of four Corulite telescoping rods with instructions. **NET ONLY \$14.70.**

Complete kit for supporting wood framework, unpainted. **NET ONLY \$8.23.**

BASSETT ROTARY ANTENNAS

Made by the makers of the famous BASSETT Concentric Line. High-Q self-supporting one-piece elements. Available in complete kits for 14 or 28 MC, in either 2 or 3 element type. Every kit is complete with all rods, supporting cross-members and mounting insulators. Less only center support, feeder cable, and drive unit.

3 ELEMENT KITS

20-3EL 14 MC \$22.50 NET 10-3EL 28 MC \$15.50 NET

2 ELEMENT KITS

20-2EL 14 MC 15.50 NET 10-2EL 28 MC 10.50 NET

SPECIAL BASSETT CONCENTRIC CABLE

Designed for use with close-spaced three-element beams. Surge impedance, 8 ohms; power-handling capacity, 1000 watts.

BCF-8-1000 Cable, 50 ft. \$7.40, 75 ft. \$10.15, 100 ft. \$12.90. Complete description with details and full information on all Bassett Rotary Beam antenna kits and Concentric cable contained in Bassett Handbook of Rotary Beam Design. Send 10c for your copy.

AMPLEX ROTARY BEAM DRIVE UNIT

The smoothest operating drive unit you've ever seen for rotating a beam array. Self-contained motor and gear drive; continuous rotation with any type of feed line; indicator-timer mechanism integral part of rotary head (indicator is sold separately); Alsinax insulation; driven speed only $\frac{3}{4}$ of 1 RPM; cast aluminum alloy rotating table; completely housed in cast aluminum alloy housing. Fool-proof and reliable in all types of weather. **AMATEUR'S NET PRICE, \$69.50.** Descriptive literature with full details sent on request.

Send for our special FREE Antenna Bulletin with descriptive literature on all the above units. Ask us how you can get YOUR Rotary Beam on our convenient Time Payment Plan. Address Dept. 14-B-9.

ALLIED RADIO

833 W. Jackson Blvd.
Chicago

NEW BOOKS

[Continued from Page 73]

Catalog No. 165A has been released by the Cornell-Dubilier Electric Corporation. This catalog consolidates the capacitor listings and descriptions appearing in catalog No. 161.

Consisting of twelve pages, this flyer is complete with concise information on all the popular items in the entire C-D line. Ideal as a quick reference for required capacitors, for servicemen and engineers. Copy available free on request at main office of plant at South Plainfield, N. J.

FUNDAMENTAL ELECTRONICS AND VACUUM TUBES, by Arthur L. Albert, M.S. First edition, November, 1938; published by the Macmillan Company, New York, N. Y. 422 pages, 6" by 9", price \$4.50 in U.S.A.

A very up-to-date and well written book for use in college and university courses covering the fundamentals of electronics and vacuum tubes. It is written for the students and instructors in

such courses; all other uses have been subjugated to this end. It should, however, be of much assistance to practicing engineers and to electrical workers who desire to review, or to study, the basic principles of the subject.

The division of the material is briefly as follows: The fundamentals of electronics and related phenomena; the electronic principles of electronic (including gas) tubes; the use of vacuum tubes as circuit elements; and photoelectric devices cathode-ray tubes, and measurements. Throughout the book, when discussions are given of electronic phenomena, these discussions are made from the new standpoint of quantum mechanics as well as from the classic theory of electron action. Through the use of the new standpoint the explanations of the operations of electronic emission, photoelectric emission, electronic conduction, gaseous conduction, and allied phenomena are more rigorous and more easily understood.

Throughout the book the latest obtainable standards of the A.I.E.E. and the I.R.E. have been followed closely. Electrical terms, accepted by the profession as a whole, instead of the unfamiliar terms of the specialist, have been used. Also, throughout each chapter numerous references have been made to external sources where more extensive or more detailed discussions of the subject at hand may be found.

DON'T Take Chances in the DX Contest

Play Safe with G-E Capacitors

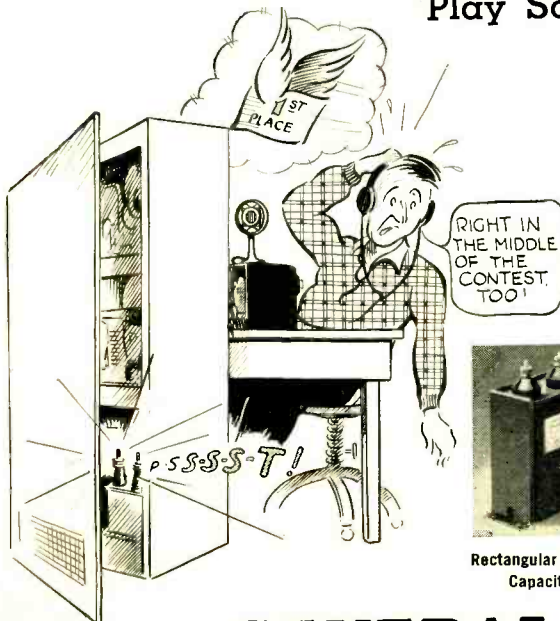

Don't run the risk of a capacitor's blowing out. Not only will you lose out in the contest, but also there's the possibility of losing rectifier tubes, plate transformer, and other valuable equipment, in addition to the capacitor.

Here's why G-E Pyranol capacitors will stand up under long hours of continuous operation: Every one is subjected to exacting tests, including a double-rated-voltage test, before it is O.K.'d for your use. Not only that, each part—Pyranol liquid, paper, metal foil, bushing—must meet rigid specifications.



Rectangular Pyranol
Capacitor

For new, low prices on G-E Pyranol capacitors or for bulletins, see your dealer or write Radio Department, General Electric, Schenectady, N. Y.

GENERAL ELECTRIC

RADIO

THE OPEN FORUM

[Continued from Page 74]

More on Little Aubrey

Washington, D. C.

Sirs:

In regard to the letter of W3CM, C. Chester Stephen, Jr., in the June *Open Forum* I would like to sound off. This undoubtedly is the most narrow-minded bit of literature I have read in any radio magazine. W3CM's case is correct in all but one item. That is the age of the lid. W3CM spoke of drinking Old Crow. He must have had a quart when he wrote that letter. I go on record as saying that you will find more lids over 25 years old than under.

Washington, D. C., is a typical city with about 265 hams. Here (except for myself) you cannot show me more than two real lids under 25 years old. I certainly would hate to make a list of those lids over 25 years old. It would be a real job.

I got my ticket when I was 14 years old. I was on the air three months before I worked the J he spoke of. It took four months to work zone 19 as he spoke of it.

Now, I do not see W3CM listed in the W.A.Z. Honor Roll. Of the 265 hams here in Washington the only ones listed are W3GGE (35 and 92) and myself, W3GHB. W3GGE is 19 and I am 17. I have spent a total of 167 days on 20 meters, and have worked 76 countries and 30 zones. I was w.a.c. and had 35 countries when I was 15, which is as good as most of the 1912 gang.

Although I am 17, I use a kw. I got the stuff for my kw. by tossing 100-pound sacks of potatoes for three summers 12 hours a

[Continued on Page 91]

You scratch their backs and they'll scratch yours

When you subscribed to "Radio" or bought this copy from your favorite dealer, did you realize that you received a gift of at least the amount you paid?

No "ham" magazine can be produced and distributed for much less than twice its "circulation revenue." Regrettable—but true. The additional value is a gift to you from our advertisers.

They've scratched your back. Isn't it fair that you scratch theirs by showing preference for their products when suited to the job at hand?

P.S. The same goes for the big "RADIO Handbook," too.

★ Now 500 and 1000 WATT CARDWELL MULTI-BAND CONDENSERS

Responding to the demands of many of our good friends in the H. P. amateur phone group, we are glad to present two new Multi-section condensers, designed to yield efficient balancer capacity values for the 10 - 20 & 80 meter phone bands.

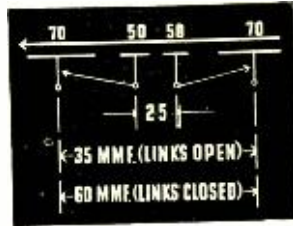

The basic diagram indicates the maximum capacities per section and the effective maximum capacities of the 3 balanced (series stator) groups.

Reference to manufacturers' tables of required capacities to resonate with such standard tank inductors as B. & W., Coto etc., discloses how nicely these effective ranges match their coils for 10 - 20 and 80 meter phone and 40 meter C. W. bands.

★ 1000 WATT Multi-Band TYPE TL-70-50-UQ

Frame—"T" type commercial (heavy N.P. brass construction).
Airgap—.294".
Plates—.050" thick aluminum, buffed and polished.
Insulation—G. E. Mycalex.
List Price—\$40.00.
Amateur Net Price—\$24.00.

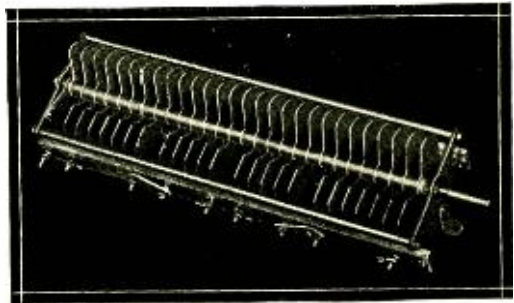

XG-70-50-XQ

★ 500 WATT Multi-Band TYPE XG-70-50-XQ

Frame—"X" standard, N.P. brass, sturdy construction.
Airgap—.171".
Plates—.040" thick aluminum, buffed and polished.
Insulation—G. E. Mycalex.
Length—13 inches back of panel.
LIST PRICE \$19.00
AMATEUR NET PRICE \$11.40

Do not fail to read T. M. Ferrilli's article on page 37, December 1938, "QST" on how to properly block D.C. from tank condensers.
And see Taylor Tubes 1939 catalog, page 36 for a 10 - 160 meter 150 watt phone built around the Cardwell XE-160-70-XQ Multi-band condenser, which many of you are already using.

THE ALLEN D. CARDWELL
MANUFACTURING CORPORATION
85 PROSPECT STREET, BROOKLYN, NEW YORK

THE NEW BUD TINY-MITES



U.H.F. Tuning Condenser

Padder Condenser

HERE'S THE DOPE!!

It is with pleasure that we announce this latest addition to the famous BUD line of condensers. These are especially desirable for applications where space is limited, and are the real answer to Ultra-high frequency tuning. Insulation is Alsimag 196. Available as follows:

- Single section:—
Single, double and triple spacing.
- Dual Section:—
Single and double spacing.
- Padder condensers for insertion in standard BUD 1½" coil forms.
- Balancing condensers for crystal filter circuits and instruments.

A wide range of capacities are available in each of the above types, and all units are very reasonably priced. Ask to see these items at your BUD jobber. Send for free descriptive literature.

BUD RADIO, INC.
CLEVELAND, OHIO., U. S. A.



Buy a Fresh Copy Today of the

RADIO AMATEUR CALL BOOK

The CALLBOOK is the only publication that lists all licensed radio amateurs in the United States and over a hundred and twenty-five different foreign countries.

Each issue also contains a world map showing amateur prefixes, press, time and weather schedules, amateur prefixes listed alphabetically and by countries and a world time conversion chart.

Complete . . . Accurate . . . Up-to-Date

Issued Quarterly

MARCH . . . JUNE . . . SEPTEMBER and DECEMBER

Annual subscription \$4.00

Single copies \$1.25

Buy your copy now from your radio jobber or direct from:

RADIO AMATEUR CALL BOOK, Inc.
606 S. Dearborn St. Chicago, Ill., U. S. A.

RADIO

The Anti-Jitterer...

By "PADDY," G2IS



"ANTI-JITTERER"
WITH 2 TYPES OF CONNECTIONS BEFORE SOLDERING

Picture Obadiah Q. Ham finishing off the wiring of his new superhet. His large red muscular fists are full of soldering iron, solder and three wires which seem to be made of high test spring steel. The idea is to solder all three together in a neat and efficient fashion. The catch is that the said three wires are buried away behind a couple of by-pass condensers in the most awkward corner of the chassis.

Obadiah grunts, shrugs his shoulders and tries again. Two of the ends seem to be well and truly soldered. He works the third end over and applies the iron; all three ends then spring into instant action. They first flicker a drop of molten solder onto Obadiah's wrist and then coyly retreat in among the other wires. Obadiah (stout fellow) can take it. He yanks the ends out again, persuades them to assemble between the jaws of his long-nose pliers. A large drop, gob or gobbet of solder

Say, O.M.,

ARE YOU INTERESTED IN A TRAVELING SALESMAN?

How about some of those parts over there on the shelf that are too good to throw away, but really aren't of any use to you now that you bought all that new stuff? If you could afford it, wouldn't you like to hire someone to sell or trade them off for you?

We didn't start out to tell you a story, but we guarantee to put you in a good humor if you try RADIO'S marketplace . . . and as for affording it! Well, just take a look at those low rates. They're at the top of page number 96.

RADIO

is picked up on the nose of the iron. Obadiah sweats in an agony of concentration. The solder begins to flow over the wire ends. Obadiah concentrates a bit too much on the wires and applies the iron to his thumb. His reactions are healthy; the chassis ends on the floor. Obadiah speaks none too gently to the three wires—one of which is now broken off short. Obadiah's wife decides to spend the evening with her mother.

You've all been through it. Now behold the cure: the anti-jitterer. Any goof can make them for a cent a hundred. Figure 1 shows the little blighter complete. You need a few pieces of brass rod of diameters varying between $\frac{1}{8}$ " and $\frac{1}{4}$ ". You need a small spool of size 26 or 28 bare tinned copper wire. Wind a tight spring on the rod. Slide it off and cut it into short lengths— $\frac{1}{4}$ " long is a pretty good size. That's all there is to it.

Now picture Obadiah (the burn has healed). Onto one of the three wires he slips the anti-jitterer. The other two wires then are inserted; to his great delight Obadiah observes that each little brute of a wire pulls against the others and as a result the whole assembly stands fast. Obadiah flows solder over the lot and the job is done, neatly and efficiently. Obadiah kisses his wife for the first time in three weeks and again she goes to spend the evening with her mother.

 gives you **MORE** for your money



SOLAREX Oil Impregnated **TRANSMITTING** **CAPACITORS**

Catalog upon request

SOLAR MFG. CORP.,
599-601 BROADWAY, NEW YORK

Low Driving Power



TYPE
254
PRICE \$12.50

HIGH POWER GAIN

Because of their scientific design and the use of a braced vertical bar tantalum grid, the 254 and other GAMMATRONS have a high power gain. This is possible because only tantalum will operate successfully with the close filament to grid spacings employed in GAMMATRON tubes. Other grid materials give rise to secondary emission when placed too close to the filament and thus they cannot successfully give the high power gain that GAMMATRONS afford.

This means that your rig is cheaper to build, requires less stages, the crystal duty is lighter, and it is easier to tune when you use GAMMATRONS.

Write for data Type 24 to 3054.
Heintz & Kaufman, So. San Francisco

 **GAMMATRON**

AN EFFECTIVE ROTARY ANTENNA

[Continued from Page 19]

the fact that usually the best ones were from the horizontal "Lazy H" array—some of them with reflectors and some without. They included such stations as VK2GU, 6MVV, and many others. In fact, I was so much impressed that I naturally decided that I wanted a similar structure. However, I faced a real problem

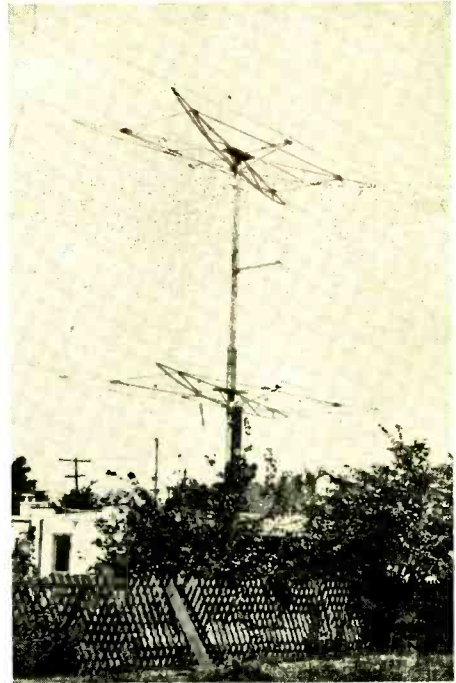

Indeed an impressive array is this rotary antenna at W6NKF, owned by Carl Yeaman who adapted aeronautical principles in designing the structural elements.

**Just Published
Beams - Verticals - Hi-Q**

Radio's first comprehensive pamphlet on antennas. Contains 9 beam diagrams, 22 vertical designs, and the new Hi-Q Vertical that does not require insulators. The most complete antenna pamphlet to date. Yours for the asking. Send postcard direct if your jobber can't supply you.

Premax Vertical Radiators for 10 and 20 meters, the new Hi-Q Vertical, and for experimental purposes.

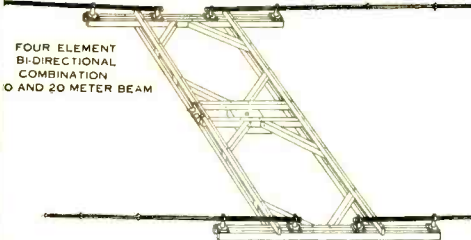

Premax Corulite Elements to build any type beam. Also complete two, three, four and six element kits. Get the complete bulletin showing hook-ups.

AT YOUR
JOBBER
OR
WRITE
DIRECT

Premax Products

Division of Chisholm-Ryder Co., Inc.
3850 Highland Ave., Niagara Falls, N. Y.

because of only a small space in which to put up an antenna for full coverage. The only possible answer was a rotary affair. And I was dead set on a "Lazy H," preferably with a reflector to make it unidirectional.

"I experimented with a number of models first. I have to smile now when I think of some of the weird contraptions used on the earlier working models. I work in an aircraft factory and it suddenly occurred to me that the same structural principles used for planes would be useful in my antenna. The result was the present 6NKF beam."

The arms of the beam are copied after the skeleton spars of airplane wings, which are designed to support tremendous weight. They extend out nine feet in length, supporting reflectors and radiators, and when the rack is completed, the overall dimensions are about 33 feet in height, with the supporting arms extending out from either side of the pole forming a horizontal X approximately sixteen feet from end to end. The upper and lower sections are constructed alike. The distance between the upper and lower sections depends

RADIO

upon the beam dimensions, which may be between sixteen and seventeen feet.

The spacing between the outer points of the X are made according to the spacing between the reflectors and radiators. For supporting the elements in the center, a short arm is extended out from the pole to the required distance depending upon the spacing used.

There are several methods of rotating the beam. W6NKF rotates his with a twelve-inch drum around the lower portion of the pole, having cables running to another twelve-inch drum mounted vertically on the wall of the operating room. For those who can afford it the beam can be operated remotely with a motor.

THE OPEN FORUM

[Continued from Page 87]

day and 18 on Saturdays. Now, Mr. Stephen, would you do this for ham radio?

I can list plenty of squirts who have done just as well. Included here is W3EVT, who likewise is no millionaire and who was the first W3 to make the Century Club, the third highest in the 1938 dx brawl and three times certificate winner in the VK-ZL test. I do not see W3CM listed as anybody in any of these items. And W3CM seemed interested in dx, too. W3GGE was the highest W3 in the 1937 D.J.D.C. contest, with a swell chance for the 1938 test. Once again I did not hear that W3CM did anything. In the 1936 S.S. contest W6KFC was second and W3EHW was fourth; W6KFC was 19 and W3EHW about 20. We find Little Aubreys who excel in every branch of operating. Here I have listed only a few cases.

Another thing, we don't hear any Little Aubreys on 20- or 80-meter phone after having a session with the bottle of Old Crow. From now on I would suggest that the 1912 egotists not put Little Aubreys and lids in the same class.

Henry Peter Meisinger, W3GHB

I Am Your Favorite

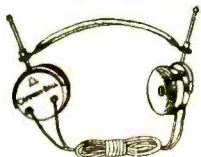

Heavy Bar Magnets greatly increase their efficiency

CANNON-BALL Headset

You get clearness and volume. Everything. Any time. Write for folder R-2 illustrating complete Cannon-Ball line.

C. F. CANNON COMPANY
SPRINGWATER, N. Y.
HEADSET HEADQUARTERS

TEN METER MOBILE EQUIPMENT

Radio Supply presents sensational new Mobile Equipment for ten meter operation in "X" Kit Form.

"GONSETT CONVERTER"

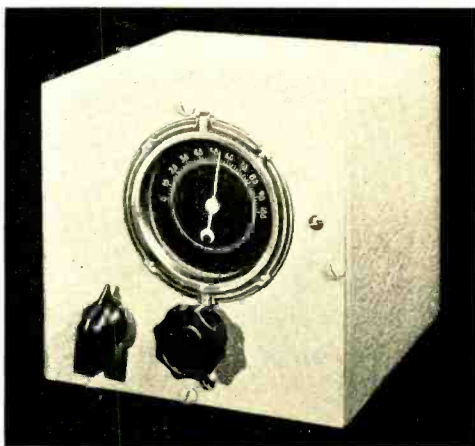

"XC1"

At last the question of ten meter mobile reception has been answered by the sensational "GONSETT" converter. So simple that you will be amazed. Just ONE tube, combined with your present auto radio and you have a marvelous ten meter Super-Heterodyne mobile receiver. Just tune your auto-radio to 1500 kc. and leave it there, tune the converter, and you have a combination unbeatable for simplicity and reception.

Uses one 6J8G or 6K8 for the high frequency oscillator and first detector.

Simple switching arrangement places auto-radio back into normal operation.

Complete kit includes stamped chassis, dial (illuminated) box and all necessary parts.

By virtue of the double i. f. system (1500 kc.-465 kc.) there are no bothersome images from other amateur signals. See January 1939 issue of "Radio" for complete story.

"XC1" complete kit	\$10.63
6J8G tube	1.35
	Total...\$11.98
Wired and tested	5.00
Complete ready to operate	\$16.98

COME IN AND SEE THIS SENSATION IN OPERATION. ASK FOR BULLETIN.

RADIO SUPPLY CO.

950 South Broadway Los Angeles TRinity 0383

THE SAGA OF THE OLD TIMER

By KERMITH TRIMBLE, W9MFT*

(A bit of a ham ditty to be sung to the tune of "Casey Jones.")

Verses (See page 94 for choruses):

1. Now this old timer was a well-known ham
 With a sweet-purrin' rig on the eighty-meter band.
 He'd worked 'em far and he'd worked 'em near,
 And he'd been working 'em year after year.
2. Old Timer thought he was pretty fine
 With a good mike voice and a handsome line.
 But he made a vow that he'd never stop
 'Til he'd worked all cont'nents as an ev-ning's crop.
3. So he tuned her up one sultry night
 When Q-R-N was simply a fright.
 He called on the rig to do its level best;
 He was out to beat the record from the east to the west.
4. Old Timer exclaimed: "I'll get 'em or bust
 If I have t' stay here until the rig be-gins to rust."
 He raised his voice in a loud CQ;
 What more, I ask you, could any ham do?
5. Then he shut her down and he turned the dial,
 While on his face he was carrying a smile.
 But this faded out just as soon as he found
 That he wasn't even getting out of town.
6. Static crashed and feedback sung
 But this Old Timer had just begun.
 He wound up the gain on the old speech amp.
 To try and make her modulate another amp.
7. The tubes got mad and the plates began to blush
 But he didn't notice 'cause he was in such a rush.
 He drove 'em and he drove 'em with a handbook in his hand,
 He was out to do his damndest to dx those foreign lands.
8. But days slipped past and the weeks went by
 Old Timer still there tryin' hard to do or die.
 He didn't take time to sleep or rest.
 Neither did he know his was a futile quest.

* 602 Union St., Emporia, Kansas.

TURNER
Sound Equipment & Catalogue
 TURNER COMPANY
 CEDAR RAPIDS, IA

How TURNER Microphones
 • Add Broadcast Quality
 • Modernize your Rig
 ... at Low Cost

TURNER offers 24 different microphones, streamlined for professional appearance and engineered to assure broadcast quality reports, to enable you to improve your equipment at amazingly low cost. Used by thousands of hams and PA men the world over.

There's a TURNER mike for every purpose—indoors or out. With the TURNER Dynamics and Crystals, you reduce feedback, breakage and blasting troubles. Own a microphone that wins you praise and doubles your enjoyment. See the TURNER mikes and equipment. Write today for TURNER'S Free Microphone bulletin No. 40-B.

Tear Out and Mail Today

TURNER CO., Cedar Rapids, Iowa

Please send me your Free Microphone Bulletin No. 40-B.

Name

Address

City..... State.....

EVERYTHING IN RADIO!

Our immense stock of radio sets, parts and supplies enables you to purchase your entire needs on one order. You'll find all your Nationally Known Favorites in this book which is FREE for the asking. Practically every order shipped same day received. WRITE FOR CATALOG.

BURSTEIN-APPLEBEE CO.
 1012-14 McGee St. • Kansas City, Mo.

9. The OT grew bent and his hair turned gray,
And cobwebs have formed on his rig to stay.
The ancient tubes have begun to go
And the moldy skyhook has started to bow.
10. Then came a night that was brittle and cold,
And the tubes and condensers knew that they were old;
When in his receiver a reply was born,
It was Gabriel's carrier and Gabriel's horn.
11. At the pearly gates Old Timer knew
That he'd raised dx and he'd met the record too;
And there right before his very dazzled eyes
Was a gold ham station—his well-earned prize.
12. He called CQ with trembling lips
As he watched the meters for sudden dips.
Great was his joy when as clear's a bell
A voice came back, "—and we're down here in Hell."

[Concluded on Next Page]

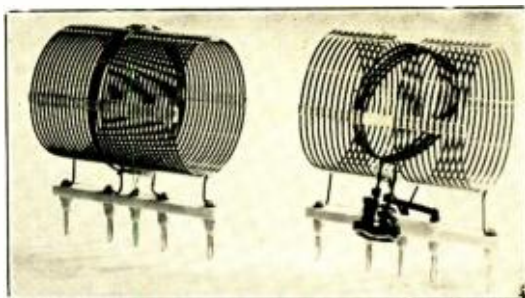

DECKER ROTATING LINK COIL

Link inbuilt with coil—therefore once set need not be readjusted each time coil is plugged in. Link and coil designed for mutually best performance.

Send for latest bulletin.

Decker Manufacturing Company

South Pasadena

California

"4-25"

EXCITER

4 BANDS
25 WATTS

Mr. W. W. Smith, W6BCX, Editor of Radio, fully describes the "4-25" in December "Radio."

The "4-25" employs no tricky circuits, no plug-in coils, and you may change bands in 5 seconds. The "4-25" may also be keyed or modulated.



Descriptive Bulletins Available

Baby Bi-Push Exciter (25 watts)	Bulletin No. 14
Bi-Push Exciter (40 watts)	Bulletin No. 15
10-20 Final	Bulletin No. 16
RT-25, RT-50 Modulator-Amplifier	Bulletin No. 17
"4-25" Exciter (25 watts)	Bulletin No. 18
Dynapush Exciter (15 watts)	Bulletin No. 19

Our "4-25" Kit includes Milliammeter, Streamlined Cabinet, Tubes, and relay for bandswitching.
 "4-25" Exciter . . . RF portionKIT \$29.50
 (If desired less meter and cabinet, deduct \$7.00)
 Power SupplyKIT \$16.00
 Prices F.O.B. Los Angeles

RADIO-TELEVISION SUPPLY CO.

"WHERE HAM SPIRIT PREVAILS"

1701 So. Grand Ave.

Los Angeles, Calif.

AMATEURS THE WORLD OVER DEPEND ON OHMITE



★ Like "tried and true" veterans, these sturdy Ohmite Vitreous-Enamelled Resistors insure continuous, trouble-free service in countless amateur and commercial installations the world over. The 10 watt and 20 watt *Brown Devils* are ideal for voltage dropping, bias units, bleeders, etc.—the *Adjustable Dividohms* for convenient voltage dividers or for quick accurate change of resistance value. 10 watts to 200 watts. ★ Ask Your Jobber also about the New Dummy Antenna.

Write Today for Free Catalog 17.



OHMITE MANUFACTURING CO.
4837 Flournoy Street ★ Chicago, Ill., U. S. A.

OHMITE

RHEOSTATS RESISTORS TAP SWITCHES

IT'S THE AUTHORITY . . . Take "Radio" Every Issue

RADIO, Ltd., Technical Publishers
7460 Beverly Blvd.
Los Angeles, California

Send **RADIO** for

- one year, \$2.50 in U.S.A. and Canada*; for
- two years, \$4.00 } foreign rates* see page 4.
- five issues, \$1.00 for new subscribers in U.S.A. and Canada* only.

Also include

- "RADIO HANDBOOK"** (\$1.50 in continental U.S.A.; elsewhere* \$1.65 or 7s.)
- "RADIO" ANTENNA HANDBOOK** (75c in continental U.S.A.; elsewhere*, 85c or 3s. 6d.)
- "RADIO TECHNICAL DIGEST"**, 2 years (2.50 in U.S.A., Canada*, Pan American countries*, elsewhere*, \$3.00 or 12s. 6d.)

Name Call

Address

City

* Remittances must be payable at par in continental U.S.A. Add 10c to Canadian checks. Canadian postal notes accepted.

Customers in British countries, please remit in dollars, only. Sterling prices temporarily withdrawn. See page 169, Jan., 1939. RADIO for details. Code: 236

13. On chilly nights when conditions are fair,
Many hams are startled when on the
air

They hear a carrier both strong and big—
It's the fourth harmonic of a Heavenly
rig.

14. Take heed, brass pounders and lads on
phone,

When things seem tough don't start to
moan,

Remember Old Timer and his ultimate
joys,

Then grin and take it like good little
boys.

Choruses:

1. Shout CQ, sign your call and listen,
Might have raised Podunk or Tim-
buctoo

Turn on the rig, and tell him how you
hear him,

Then when he comes back, why he'll
give R9 too.

2. Shout CQ, sign your call and listen
Over the dial, 'til you hear someone;
May be dx, may be just a local,

But it's all called hamming, and that's
the way it's done.

TRIMM Commercial Headsets for

discriminating amateurs. Ultra-sensitive, lightweight,
yet ruggedly constructed. The *PHONE* for your rig!

Write Dept. R-12 for folder.

TRIMM RADIO MFG. CO. 1770 W. Berteau Ave.
Chicago, Ill.

DX with a "W.A.Z." MAP

The simplest and quickest way to tell
which and how many zones you work
during the dx marathon is to have one
of RADIO'S W.A.Z. maps near your rig.
A list of countries is included.

The W.A.Z. plan is the best "yard-stick"
yet developed for the measurement of
DX achievement.

TWENTY FIVE CENTS

postpaid, anywhere. Canadian postal notes
(25c) accepted. Five international postal reply
coupons accepted as 25c.

RADIO, LTD.

7460 BEVERLY BLVD., LOS ANGELES

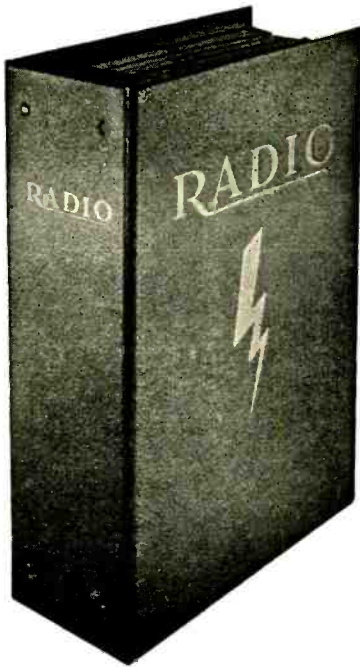

A BINDER

FOR YOUR COPIES OF "RADIO"

- takes them from dusty corners
- protects valuable references
- places one year's developments in radio at your finger tips

AND ALSO HOLDS THAT BIG,
NEW RADIO HANDBOOK

Now only \$1.00
express collect in continental U. S. A.
Elsewhere \$1.25, postpaid

Radio, Ltd., 7460 Beverly Blvd.,
Los Angeles California

Over

600 MANUFACTURERS PAGES

FULL SPECIFICATIONS—AMPLE ILLUSTRATIONS—LIST PRICES

Classified Directory of Over 1000 Manufacturers of Radio Parts and
Equipment—Names—Addresses—Products Made

Alphabetically and Cross Indexed

Index of Trademarks, Registered Names and Their Owners

You'll find it

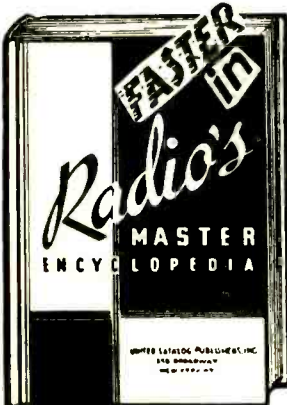

RADIO'S MASTER ENCYCLOPEDIA

• YOUR BUYING GUIDE — The only book of its kind published. Over 500 pages. Hundreds of different manufacturers. Thousands of different items. All clearly catalogued. Illustrations—complete specifications—list prices—make buying easy and intelligent to anyone connected with Radio and Allied Industries.

• YOUR REFERENCE BOOK — A wealth of information on American-made Radio Products is immediately available. It might take days, weeks or months hunting for data—but with Radio's Master Encyclopedia it is at your finger tips.

• YOUR SALES CATALOG — If you sell radio products you will find Radio's Master Encyclopedia indispensable. Use it as your own sales catalog. Show it to your customers and solicit orders from it.

• EASY TO USE—Every item in this book is indexed and cross-indexed as to classification, manufacturers' names and addresses, and page numbers for instant reference. A complete classified directory of 1000 manufacturers in the radio industry. Additional index of trade marks, trade names and registered names, with addresses of owners. You will find it "FASTER" in the "MASTER."

IF—

you are in any way connected with Radio or Allied industries—if you buy—if you sell—if you manufacture—you cannot specify—if you manufacture—you cannot afford to be without this—only

\$3.50

POSTPAID
in U.S.A. and
CANADA
Remittance with
order

OFFICIAL" Radio
MASTER BOOK

UNITED CATALOG PUBLISHERS
258 Broadway, New York City

The Marketplace

Classified Advertising

(a) Commercial rate 10c per word, cash with order; minimum, \$1.00. Capitals: 13c per word. For consecutive advertising, 15% discount for 3d, 4th, and 5th insertions; 25% thereafter. Break in continuity restores full rate. Copy may be changed as often as desired.

(b) Non-commercial rate: 5c per word, cash with order; minimum, 50c. Available only to licensed amateurs not trading for profit; our judgment as to character of advertisement must be accepted as final.

(c) Closing date (for classified forms only): 25th of month; e.g., forms for March issue, published in February, close January 25th.

(d) No display permitted except capitals. (e) Used, reclaimed, defective, surplus, and like material must be so described.

(f) Ads not relating to radio or radiomen are acceptable but will be grouped separately.

(g) No commissions nor further discounts allowed. No proofs, free copies, nor reprints sent.

(h) Send all Marketplace ads direct to Los Angeles accompanied by remittance in full payable to the order of Radio, Ltd.

USED Receivers. Crystal Ultra Skyrider and three other receivers. Must sell. \$18 to \$57. Write Milles, 1650 West 36 Street, Los Angeles.

USED tubes, one HF300, \$14.50; two \$75.00-HK654's, \$25 each. All in first class condition. W7DES, C/o KDFN, Casper, Wyo.

QSL's SWL's: one color, 45c; two colors, 60c hundred, postpaid. Samples. W1FTM, 268 Piedmont, Waterbury, Conn.

LISTEN for High Frequency Broadcast Station, W9XA, 26,450 kilocycles, Kansas City, Missouri.

7 x 10 x 6 1/4" steel cabinets. Hinged cover. Chassis. \$1.85. R. H. Lynch, 970 Camulos, Los Angeles, Calif.

REAL bargains in uncased PRECISION TRANSFORMERS. 3000 volts center-tapped at 250 mils—\$6.00. 5000 volts center-tapped at 250 mils—\$9.00. Michigan Electrical Laboratory, Muskegon, Mich.

W6KX QSL's cost more—are worth more. Printed by Keith LaBar, 1123 North Bronson Avenue, Hollywood, California. Special cards made to order for the discriminating amateur.

25-WATT MODULATOR described in January issue, page 72. Laboratory model for sale. \$26.00 f.o.b., shipped express collect. RADIO, Ltd., 7460 Beverly Blvd., Los Angeles, Calif.

MUST sell new SX 16 Skyrider, \$95. Write. Alois Krispinsky, 712 Mabel, Youngstown, Ohio.

BARGAIN—W9DIU's complete station, including 80-160M fone-c.w., 40-meter c.w., parts of all kinds. Write for dope. W9LFH, Harold S. Roth, Algona, Iowa.

CRYSTALS MOUNTED: 40X \$1.60; 160-80 \$1.25; COD's accepted. Pacific Laboratories, 344 Fetterly, Los Angeles.

CRYSTALS: Airmailed; see January issue. Special 20M mounted \$4.50. COD's accepted. C-W Mfg. Co., 1170 Esperanza. AN 7310 Los Angeles.

QSL's: 75c for 100; 2 colors, \$1.80 for 300. Postpaid. W9DGH, 2005 North Third Ave., Minneapolis, Minn.

QSL's—HIGHEST QUALITY—LOWEST PRICES. RADIO HEAD-QUARTERS, FT. WAYNE, INDIANA.

YOUR sigs recvd hr., phone CQ's, etc., on guaranteed phonograph records, special 35c. Brown's Radio Laboratory, Dolgeville, New York.

METERS repaired, redesigned, swapped, W9GIN, 2812 Indiana, Kansas City, Missouri.

BEST place on earth to buy Ham stuff. All popular lines stocked. W9KJF, Indianapolis, Indiana.

Advertising Index

Allied Radio Corp.	85	Premax Products	90
Bliley Electric Co.	83	Radio Amateur Call Book	88
Bud Radio, Inc.	88	RADIO <i>Antenna Handbook</i>	81
Burstein-Applebee Co.	92	RADIO Binder	95
Cannon Co., C. F.	91	RADIO <i>Handbook</i>	79
Cardwell Manufacturing Corp.,		RADIO TECHNICAL DIGEST	6
The Allen D.	87	RADIO WAZ Map	94
Centralab	77	RCA Mfg. Corp.	Cover 4
Chicago Radio Apparatus Co.	97	Radio Supply Co.	91
Cornell-Dubilier Electric Corp.	84	Radio-Television Supply Co.	93
Crowe Name Plate & Mfg. Co.	80	Signal Electric Mfg. Co.	76
Decker Mfg. Co.	93	Solar Mfg. Co.	89
Eitel-McCullough, Inc.	3	Taylor Tubes, Inc.	Cover 3
General Electric	86	Thordarson Electric Mfg. Co.	Cover 2
Guthman & Co., Inc., Edwin I.	82	Trimm Radio Mfg. Co.	94
Heintz and Kaufman, Ltd.	89	Turner Co.	92
Mallory, P. R., & Co.	75	United Catalogue Publishers	95
Newton Institute of Applied Science	83	Ward Leonard Electric Co.	80
Ohmite Manufacturing Co.	94	Wholesale Radio Service Co., Inc.	78

Buyer's Guide

● Where to Buy It ●

PARTS REQUIRED FOR BUILDING EQUIPMENT SHOWN IN THIS ISSUE

The parts listed are the components of the models built by the author or by "Radio's" Laboratory staff. Other parts of equal merit and equivalent electrical characteristics usually may be substituted without materially affecting the performance of the unit.

TURNER AMPLIFIER

Page 20

C₁—Aerovox MM50
C₂, C₄—Solar TT-35
C₃, C₅, C₆, C₇—Solar type S
C₇, C₈—Solar TT-36
C₁₀, C₁₁, C₁₂, C₁₃—Aerovox GLS-250
R₁ to R₆ incl.—Centralab 510
R₇—Centralab 72-105
R₈ to R₁₂ incl.—Centralab 510
R₁₃—Ohmite Brown Devil
R₁₄, R₁₅—Centralab 510
R₁₆—Centralab 514
T₁—UTC PA132
T₂—UTC PA333
T₃—UTC PMV2
CH₁—UTC S-31
CH₂—UTC S-27
Tubes—RCA

RYDER TRANSMITTER

Page 23

R. F. Section

C₁, C₂—Bud 911
C₃—Bud 92
C₄, C₅—Bud 892
C₆, C₈, C₁₁, C₁₂, C₁₃, C₁₆, C₁₇—Aerovox 1467
C₇, C₁₄—Aerovox 1450
C₁₅—Aerovox 1455
C₁₈—Aerovox 1457
R₁, R₂, R₃, R₄, R₅, R₁₂, R₁₃, R₁₄, R₁₅—Ohmite "Brown Devil"
T₁—Thordarson T-19F79
T₂—Thordarson T-74F23
RFC—Bud 920
RFC₁—Bud 568

Power Supplies

C₁, C₂—Aerovox 1009
C₃, C₄—Aerovox 2009
R₁—Ohmite 0318
R₂—Ohmite 0788
R₃—Ohmite 0971
R₄—Ohmite "Brown Devil"
T₁—Thordarson T-50F61
T₂—Thordarson T-19P55
T₃—Thordarson T-64F21
T₄—Thordarson T-19P61
CH₁—Thordarson T-19C35
CH₂—Thordarson T-19C42

ILLINOIS—Chicago

CHICAGO RADIO APPARATUS CO., Inc.

Established 1921

415 SOUTH DEARBORN STREET
(Near Van Buren Street)

ALL SUPPLIES FOR THE SHORT WAVE
FAN AND RADIO AMATEUR. QUOTA-
TIONS FREELY GIVEN ON ANY KIT
OR LAYOUT

Short Wave Receivers Taken in Trade
Get our low prices

CH₃—Thordarson T-19C36
CH₄—Thordarson T-19C43

PULSING TRANSMITTERS

Page 28

Grid controlled pulser tubes:
Type 128, 128A—DuMont
KY-21—Eimac
KU-627—Westinghouse
FG-17—General Electric

SHEFFIELD PUSH BUTTON CONTROL

Page 35

Control relays—Guardian Series 5 or 15

PATTERSON AMPLIFIER

Page 38

Figure 3

C₁, C₆, C₂₅—Solar type DT-882
C₂, C₇, C₁₀, C₂₇—Solar LG-5
C₁₉—Bud type 828
CH₁—Thordarson type 9320
S₂—Bud type 1071
S₃—Yaxley 1313L
Resistors—Centralab carbon
Coupling condensers—Solar "Domino"
By-pass condensers (tubular)—Cornell-Dubilier DT
Gain Controls—Centralab, no. 6 taper

Buyer's Guide

Continued

Patterson Amplifier

BC—Mallory Bias Cell Unit
Jacks—Bud type 230
Tuning dial—Gordon

Figure 4

T₁—Stancor type R-4050
T₂—Stancor type P-4080
C₁, C₂—Solar Z-216
C₃—Solar D-808
C₄, C₅—Solar D828
CH₁—Stancor C-1421
CH₂, CH₃—Stancor C-1001
R—Ohmite Brown Devil
Pilots and indicator jewels—Mallory Yaxley

GLEED REMOTE CONTROL

Page 42

A, F, H, I—Home built, for 1.5-volt operation
B, C—Automatic Electric Co. ASR1A1B
D, G—Struthers-Dunn CXA-2126
E—Automatic Electric Co. AQ1A2B
Selector mechanism—Automatic Electric Co.
RA701A1D
Dial mechanism—Automatic Electric Co. 24A36
Tubes—RCA

250-WATT TRANSMITTER

Page 48

R. F. Chassis

C₁—Cornell-Dubilier DT-4S1
C₂, C₈, C₁₀—Cardwell ZR-50-AS
C₃, C₄, C₆, C₁₁—Cornell-Dubilier 4-6D2
C₅, C₇—Cornell-Dubilier 4-6Q5
C₉, C₁₂, C₁₃, C₁₅, C₁₄, C₁₈, C₁₉, C₂₀, C₂₁, C₂₅—
Cornell-Dubilier 4-6D6
C₁₇—Cardwell ER-25-AD
C₂₄—Cornell-Dubilier 9-25D2
C₂₈—Cardwell NP-35-ND
R₂, R₃, R₅, R₆, R₉, R₁₄, R₁₅, R₁₇—Ohmite "Brown
Devil"
RFC—Bud 920
S₁—Yaxley 1326L
T₁—Thordarson T-73F60
T₂—Thordarson T-19F96

Power Supply and Modulator

C₁, C₄—Cornell-Dubilier EDJ-2101
C₂—Cornell-Dubilier DT-4S1
C₃, C₅, C₆—Cornell-Dubilier DT-4P25

C₇—Cornell-Dubilier EDJ-5050
C₈, C₉—Cornell-Dubilier KR-548
C₁₀—Cornell-Dubilier TJU-15040
C₁₁—Cornell-Dubilier TJU-15020
C₁₂, C₁₃—Cornell-Dubilier KR-548
C₁₄—Cornell-Dubilier TJU-10020
C₁₅—Cornell-Dubilier TJU-10040
R₄—Yaxley type M
R₈, R₉—Ohmite "Brown Devil"
R₁₀, R₁₃—Ohmite 0588
R₁₁—Ohmite 0374
T₁—Thordarson T-62A26
T₂—Thordarson T-61A94
T₃—Thordarson T-11M77
T₄—Thordarson T-70R62
T₅—Thordarson T-19F88
T₆—Thordarson T-19F96
T₇—Thordarson T-19P64
T₈—Thordarson T-15R60
T₉—Thordarson T-15D79
T₁₀—Thordarson T-19F89
T₁₁—Thordarson T-19F90
T₁₂—Thordarson T-15P13
X₁₁—Bliley B-5
HF-100's and ZB-120's—Amperex
Other tubes—RCA

GONSETT'S MOBILE TRANSMITTER

Page 54

Carbon resistors—Centralab 516
Fixed mica condensers—Solar MW
C₁₁, C₁₂—Mallory FPD 410
C₁₄, C₁₅, C₁₆—Mallory FPB 410
Relay 1—Guardian series 115 single-pole single-
throw
Relay 2—Guardian series 115 double-pole double-
throw
C₇—Cardwell ZR25AS
CH₁, CH₂—Thordarson T53-C-19
Vibrator packs—Mallory 552

HARRELL MODULATION INDICATOR

Page 57

C₁, C₂, C₃—Cornell-Dubilier 1W
C₄—Cornell-Dubilier DT-4S1
R₁—Mallory-Yaxley A1OMP
R₂—Mallory-Yaxley A2MP
R₃—Mallory-Yaxley A1MP
R₄—Centralab 516
RFC—Bud 920
T—General Transformer Co. # 1063

Easier TO DRIVE

**FULL
RATED
INPUT**

**“HOW
MUCH DOES IT
TAKE TO DRIVE IT”? —**

is a commonly discussed subject among amateurs.

Taylor Tubes points with pride to the performance of its *ideal* Buffer-Doubler—Final Amplifier Tube—the *new popular* TZ-40.

This wonder tube can be excited to full rated input directly by any crystal oscillator stage and the output will fully drive a class C amplifier at up to 600-700 watts input. Note the technical data on the TZ-40 doubler stage in the H.F. portion of the DeLuxe Dual Unit 275 watt transmitter shown in the 1939 Taylor Manual. This TZ-40 operating at 850 volts—60 MA with 7 MA grid current through the 25,000 ohm bias resistor delivers up to 80 MA to the Final Amplifier while doubling from 10 to 5 meters. There is no need for high priced tubes when results like this can be secured so easily. Plan on using a TZ-40 as Buffer or Doubler and save up to \$12.50 in tube cost in this one stage alone. A T-40 or TZ-40 never requires more than 5 watts excitation in any service. Over 10,000 T-40's and TZ-40's in daily service give true testimony to real results.

NEW TAYLOR MANUAL READY

It's ready—and your distributor is saving a copy for you. Chock full of tested technical data and the most modern transmitting circuits. *It's yours for the asking.*

THEY'RE COMING SOON!!

• • •
A NEW SERIES OF “THIN WALL” CARBON ANODE TUBES WILL BE ANNOUNCED BY TAYLOR IN THE NEAR FUTURE. WATCH OUR ADS.
• • •

“More Watts Per Dollar”

Taylor — HEAVY — **CUSTOM BUILT** — DUTY — **Tubes**

TAYLOR TUBES, INC., 2341 WABANSIA AVE., CHICAGO, ILLINOIS

Get 260 watts output with less than 1 watt driving power...with

NEW RCA 813

It's not a claim—it's an actual fact! The new RCA 813 will give you 260 watts output in Class "C" telegraph service with less than 1 watt of driving power! Needs no neutralization, and a pair of 813's makes a swell final for quick-band-change, high power transmitters.

Only 7½" long, the RCA 813 employs a new stem structure with very short heavy leads and low lead inductance. This new high power beam tube may be operated at full ratings up to 30 megacycles without neutralization.

\$28⁵⁰ AMATEUR NET

One of the finest transmitting tubes RCA has ever developed, the 813 also features heavy-duty thoriated-tungsten filament, oversized graphite plate, dome-top bulb with cushion mount supports, low screen current, and a new giant 7-pin base with short shell and wide pin spacings.

Typical operation of RCA 813, Class "C" Telegraphy... filament voltage, 10 volts (a.c. or d.c.); filament current, 5 amperes; D-C plate voltage, 2000 volts; D-C screen voltage, 400 volts; D-C grid voltage, minus 90 volts; D-C plate current, 180 milliamperes; D-C screen current, 15 milliamperes; Driving power, 0.5 watt; Power output, 260 watts.



GET HIGH POWER AND SAVE 4 WAYS

WITH THE RCA 810

This tube enables you to save on initial cost—cost of tank circuit capacitors; cost of power supply equipment—and cost of driver stage. And when it comes to high power—you'll say the 810 is FB! For it gives you plenty!

Two RCA 810's, in Class "C" telegraph service, will take one kilowatt of power at a plate voltage of only 2000 volts and a driving power of 24 watts.

The RCA 810 is of the high-mu triode type and has extremely high permeance. It features a heavy-duty thoriated-tungsten filament, a filament shield at each end which prevents escape of stray electrons, and large rugged terminals at top and side of the bulb. May be operated at frequencies as high as 30 megacycles at maximum ratings.

Maximum ratings of RCA 810, Class "C" Telegraphy... D-C plate voltage, 2000 volts; D-C plate current, 250 milliamperes; Plate input, 500 watts; Plate dissipation, 125 watts.

\$13⁵⁰ AMATEUR NET

The Nov.-Dec. issue of "Ham Tips" contains circuit information on above tubes. Ask your RCA Power Tube Distributor for your copy.

Listen to the "Magic Key of RCA" every Sunday, 2 to 3 P.M., E.S.T., on the NBC Blue Network.

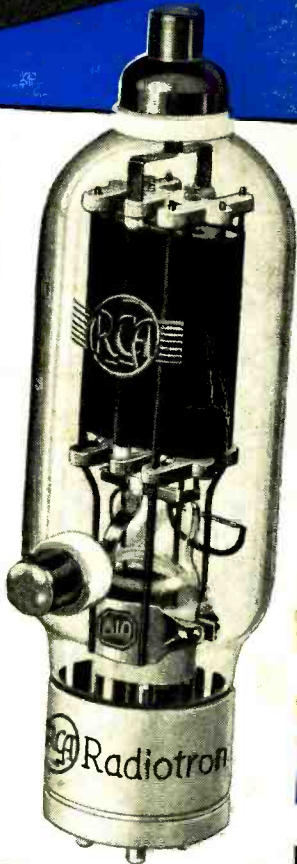

PRICES REDUCED!

With prices reduced on the following RCA power tubes you now have an excellent opportunity to save money. Compare these prices!

RCA 203-A was \$15.00	Now \$10.00
RCA 204-A was 97.50	Now 85.00
RCA 211 was 15.00	Now 10.00
RCA 803 was 34.50	Now 28.50
RCA 837 was 8.50	Now 7.50
RCA 838 was 16.00	Now 11.00
RCA 845 was 15.00	Now 10.00
RCA 849 was 135.00	Now 120.00
RCA 866-A was 4.00	Now 2.50
RCA 872 was 14.00	Now 9.00
RCA 872-A was 16.50	Now 11.00



Radio Tubes

FIRST IN METAL • FOREMOST IN GLASS • FINEST IN PERFORMANCE

RCA MANUFACTURING CO., INC., CAMDEN, N. J.

A Service of the Radio Corporation of America